



FY23
DEALERBOOK

mongoose

2023

mongoose.



**B
E
A
W**

HARDTAIL



SWITCHBACK HARDTAIL



SWITCHBACK COMP
WOMEN'S



SWITCHBACK SPORT



SWITCHBACK SPORT
WOMEN'S

MONTANA HARDTAIL



MONTANA SPORT



MONTANA SPORT
WOMEN'S

FIREBALL HARDTAIL



FIREBALL SS



FIREBALL

mongoose.

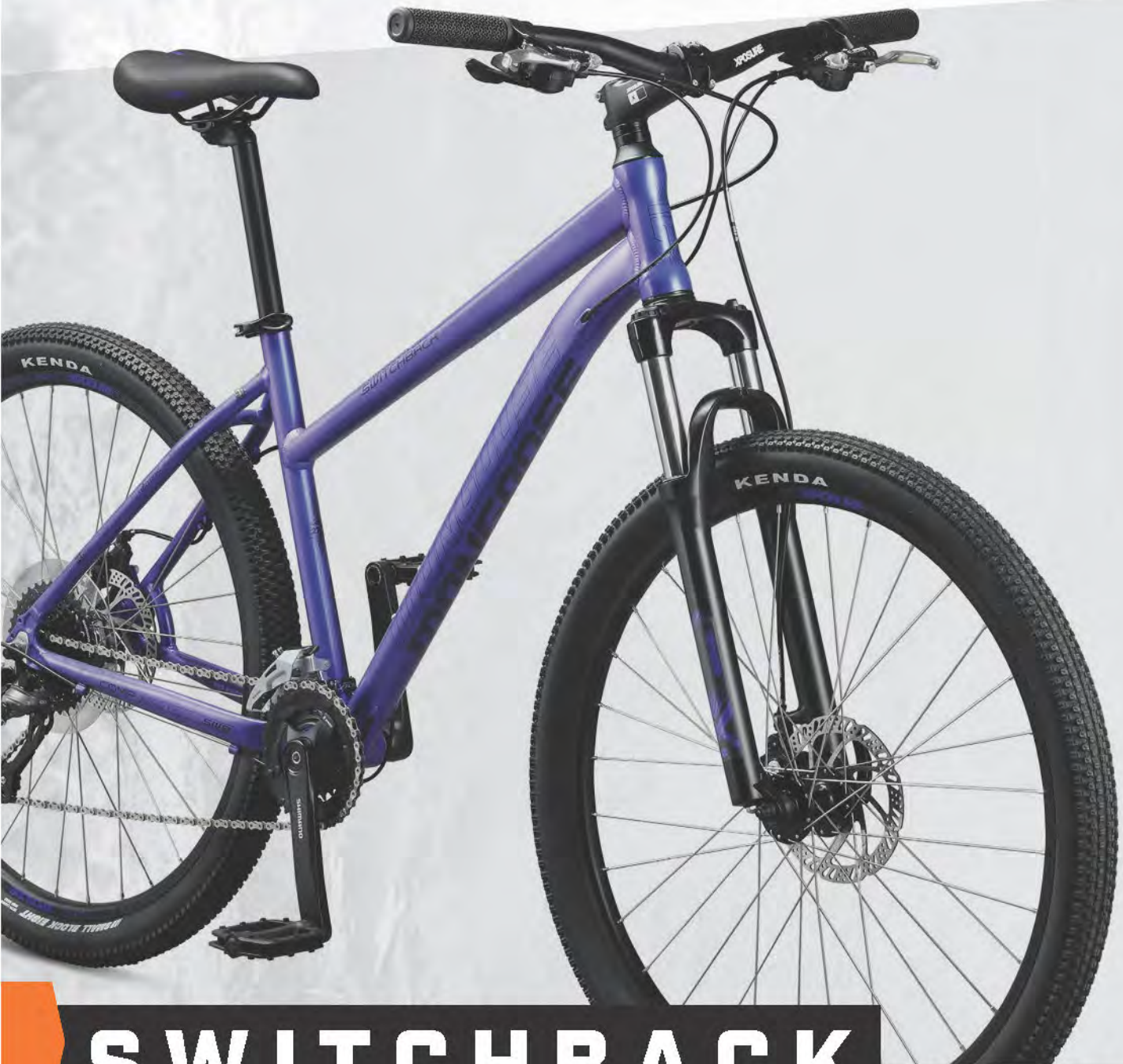

SWITCHBACK

As a staple of the Mongoose mountain bike assortment dating back to 1988, the Switchback was designed with everything a rider needs to take on single track trails or put in mile after mile on crushed gravel paths – all at an excellent value.

RIDER
PROFILE

A rider who is looking for a well-rounded, comfortable mountain bike that inspires confidence.



SWITCHBACK COMP 27.5" WOMEN'S























PURPLE / M25201F10

🔪	FRAME	Tectonic T1, aluminium, 27.5" sport geometry, internal cable routing, 9 mm x 135 mm dropout, replaceable hanger	☼	SPOKES	146, stainless steel
🏠	FORK	Xposure, 27.5", steel steerer, lockout, 9 mm x 100 mm, QR, 80 mm travel	🌀	TYRES	Kenda MTB, 27.5 in x 2.1 in, wire bead
⚙️	CRANK	Shimano MT-101-2, aluminium, 36/22T	🚲	PEDALS	Mongoose, nylon
🔗	CHAIN	KMC Z9	🛑	BRAKES	Tektro aluminium mechanical disc, 160 mm rotor, mechanical, aluminium, 160 mm rotor
🔩	BOTTOM BRACKET	Feimin FP-B609W, cartridge, 3-piece, threaded 73 mm shell	🏹	HANDLEBARS	Xposure, double-butted aluminium, 680 mm width, 25 mm rise, 31.8 mm clamp
🔩	REAR COG	Shimano, 9-speed, 11-36T	🏹	STEM	Xposure diecast, threadless, 70 mm/90 mm, 7°, 31.8 mm clamp
🔩	FRONT DERAILLEUR	Shimano FD-2020, band clamp	🔩	HEADSET	Threadless, ZS44/ZS44, retainer bearing
🔩	REAR DERAILLEUR	Shimano Altus RD-M370	🏠	SEAT POST	Xposure, aluminium, 350 mm, 20 mm offset, 31.6 mm
🔩	RIMS	Xposure MD-16, aluminium double wall, 19 mm ID, 32H	🏹	SADDLE	Mongoose MTB comfort, steel rails
🔩	FRONT HUB	Xposure, aluminium, ball bearing, 9 mm x 100 mm, 32H, 6-bolt	🔩	GRIPS	Xposure, single density
🔩	REAR HUB	Xposure, aluminium, ball bearing, 9 mm x 135 mm, 32H, 6-bolt	🏠	SIZES	SM, MD



SWITCHBACK SPORT 27.5" MEN'S























BLACK / M25301M10

	FRAME	Tectonic T1, aluminium, 27.5" sport geometry, internal cable routing, 9 mm x 135 mm dropout, replaceable hanger		SPOKES	140, stainless steel
	FORK	Xposure, 27.5", steel steerer, lockout, 9 mm x 100 mm, QR, 80 mm travel		TYRES	Xposure MTB, 27.5 in x 2.1 in, wire bead
	CRANK	Prowheel TM-CY10, aluminium, 36/22T		PEDALS	Mongoose, nylon
	CHAIN	KMC Z8		BRAKES	Mongoose, mechanical, aluminium, 160 mm rotor
	BOTTOM BRACKET	Feimin FP-B609W, cartridge, 3-piece, threaded 73 mm shell		HANDLEBARS	Xposure, double-butt aluminium, 700 mm width, 25 mm rise, 31.8 mm clamp
	REAR COG	Sunrace, 8-speed, 11-34T		STEM	Xposure diecast, threadless, 70 mm/90 mm, 7°, 31.8 mm clamp
	FRONT DERAILLEUR	Shimano FD-M315, band clamp		HEADSET	Threadless, ZS44/ZS44, retainer bearing
	REAR DERAILLEUR	Shimano RD-TX800		SEAT POST	Xposure, aluminium, 350 mm, 20 mm offset, 31.6 mm
	RIMS	Xposure MD-16, aluminium double wall, 19 mm ID, 32H		SADDLE	Mongoose MTB comfort, steel rails
	FRONT HUB	Xposure, aluminium, ball bearing, 9 mm x 100 mm, 32H, 6-bolt		GRIPS	Xposure, single density
	REAR HUB	Xposure, aluminium, ball bearing, 9 mm x 135 mm, 32H, 6-bolt		SIZES	XS, SM, MD, LG, XL



SWITCHBACK SPORT 27.5" WOMEN'S

BLACK / M25301F10

 FRAME	Tectonic T1, aluminium, 27.5" sport geometry, internal cable routing, 9 mm x 135 mm dropout, replaceable hanger	 SPOKES	146, stainless steel
 FORK	Xposure, 27.5", steel steerer, lockout, 9 mm x 100 mm, QR, 80 mm travel	 TYRES	Xposure MTB, 27.5 in x 2.1 in, wire bead
 CRANK	Prowheel TM-CY10, aluminium, 36/22T	 PEDALS	Mongoose, nylon
 CHAIN	KMC Z8	 BRAKES	Mongoose, mechanical, aluminium, 160 mm rotor
 BOTTOM BRACKET	Feimin FP-B609W, cartridge, 3-piece, threaded 73 mm shell	 HANDLEBARS	Xposure, double-butted aluminium, 680 mm width, 25 mm rise, 31.8 mm clamp
 REAR COG	Sunrace, 8-speed, 11-34T	 STEM	Xposure diecast, threadless, 70 mm/90 mm, 7°, 31.8 mm clamp
 FRONT DERAILLEUR	Shimano FD-M315, band clamp	 HEADSET	Threadless, ZS44/ZS44, retainer bearing
 REAR DERAILLEUR	Shimano RD-TX800	 SEAT POST	Xposure, aluminium, 350 mm, 20 mm offset, 31.6 mm
 RIMS	Xposure MD-16, aluminium double wall, 19 mm ID, 32H	 SADDLE	Mongoose MTB comfort, steel rails
 FRONT HUB	Xposure, aluminium, ball bearing, 9 mm x 100 mm, 32H, 6-bolt	 GRIPS	Xposure, single density
 REAR HUB	Xposure, aluminium, ball bearing, 9 mm x 135 mm, 32H, 6-bolt	 SIZES	SM, MD

mongoose.



MONTANA

The Mongoose Montana is an entry level mountain bike that is trail-ready for some good old fashioned mountain fun.

Pedaling is easier than ever with the aluminum hardtail mountain frame.

RIDER
PROFILE

A rider who is looking for a well-rounded, comfortable mountain bike that inspires confidence.



MONTANA SPORT 27.5" MEN'S

BLACK/ORANGE / M26151M10

🔪	FRAME	Aluminum, 27.5" sport geometry, internal cable routing, 9 mm x 135 mm dropout, replaceable hanger	🌀	TYRES	Xposure MTB, 27.5 in x 2.1 in, wire bead
🏠	FORK	SR Suntour XCE 28, steel steerer, pre-load adjust, 9 mm x 100 mm, QR, 80 mm travel	🚲	PEDALS	Mongoose, nylon
🔗	CRANK	Prowheel TM-CY10, aluminum, 36/22T	🛑	BRAKES	Mechanical, aluminium, 160 mm rotor
🔗	CHAIN	KMC Z9	🏠	HANDLEBARS	Xposure, aluminum, 650 mm width, 15 mm rise, 31.8 mm clamp
🔗	BOTTOM BRACKET	Feimin FP-B609W, cartridge, 3-piece, threaded 73 mm shell	🔗	SHIFTERS	Microshift TS39-29, 2 x 9 trigger
▶	REAR COG	Sunrace, 9-speed, 11-36T	🚲	STEM	Xposure diecast, threadless, 70 mm/90 mm, 7°, 31.8 mm clamp
🔗	FRONT DERAILLEUR	Microshift, 31.8 mm clamp	🔗	HEADSET	Threadless, ZS44/ZS44, retainer bearing
🔗	REAR DERAILLEUR	Microshift RD-M36S	🏠	SEAT POST	Steel, 300 mm, 28.6 mm
🔗	RIMS	Xposure, aluminum double wall, 19 mm ID, 32H	🚲	SADDLE	Mongoose MTB comfort, steel rails
🔗	FRONT HUB	Xposure, aluminum, ball bearing, 9 mm x 100 mm, 32H, 6-bolt	🔗	GRIPS	Xposure, single density
✳️	SPOKES	14G, stainless steel	📏	SIZES	SM, MD, LG



RED / M26151M20



MONTANA SPORT 27.5" WOMEN'S

MINT / M26151F10

 FRAME	Aluminum, 27.5" sport geometry, internal cable routing, 9 mm x 135 mm dropout, replaceable hanger	 TYRES	Xposure MTB, 27.5 in x 2.1 in, wire bead
 FORK	SR Suntour XCE 28, steel steerer, pre-load adjust, 9 mm x 100 mm, QR, 80 mm travel	 PEDALS	Mongoose, nylon
 CRANK	Prowheel TM-CY10, aluminum, 36/22T	 BRAKES	Mechanical, aluminium, 160 mm rotor
 CHAIN	KMC Z9	 HANDLEBARS	Xposure, aluminum, 650 mm width, 15 mm rise, 31.8 mm clamp
 BOTTOM BRACKET	Feimin FP-B609W, cartridge, 3-piece, threaded 73 mm shell	 SHIFTERS	Microshift TS39-29, 2 x 9 trigger
 REAR COG	Sunrace, 9-speed, 11-36T	 STEM	Xposure die cast, threadless, 70 mm/90 mm, 7°, 31.8 mm clamp
 FRONT DERAILLEUR	Microshift, 31.8 mm clamp	 HEADSET	Threadless, ZS44/ZS44, retainer bearing
 REAR DERAILLEUR	Microshift RD-M36S	 SEAT POST	Steel, 300 mm, 28.6 mm
 RIMS	Xposure, aluminum double wall, 19 mm ID, 32H	 SADDLE	Mongoose MTB comfort, steel rails
 FRONT HUB	Xposure, aluminum, ball bearing, 9 mm x 100 mm, 32H, 6-bolt	 GRIPS	Xposure, single density
 SPOKES	140, stainless steel	 SIZES	SM, MD



PINK / M26151F20

mongoose.



FIREBALL

The Fireball is Mongoose® pro rider Greg Watts' weapon of choice whether he's competing on the world's most insane slope style courses or riding his backyard trails at home. With durable Tectonic® T1 aluminium construction and a tapered head tube, the fireball is ready for any dirt jumps or big-wheeled street riding you can throw at it.

RIDER
PROFILE

For the slopestyle,
street or trail rider who
wants to send it.



FIREBALL SS 26" UNISEX

CYAN / M29501M100S

🔪	FRAME	Tectonic T1, aluminium, 26" dirt jump geometry, 9 mm x 135 mm dropout, replaceable hanger	🌀	TYRES	Kenda Small Block, 26 in x 2.35 in, wire bead
🏠	FORK	Manitou Circus Expert, 26", aluminium steerer, 20 mm x 110 mm, thru axle, 100 mm travel	⚙️	PEDALS	Mongoose, aluminium
⚙️	CRANK	Samox CW-1448M, aluminium, 25T	🛑	BRAKES	Mongoose, front mechanical, rear hydraulic, aluminium, 160 mm rotor
🔗	CHAIN	KMC Z510	🏎️	HANDLEBARS	Xposure double-butt, aluminium, 750 mm width, 30 mm rise, 31.8 mm clamp
🔗	BOTTOM BRACKET	Samox, Euro cartridge bearing, 8-spline axle, threaded 68 mm shell	🏎️	STEM	Promax DA-269, aluminium, threadless, 40 mm, 7°, 31.8 mm clamp
🔗	REAR COG	Formula, single-speed, 12T	🔗	HEADSET	Threadless, ZS44/ZS44, retainer bearing
🔗	REAR DERAILLEUR	Shimano Altus RD-M2000	🏎️	SEAT POST	Xposure, aluminium, 200 mm, integrated saddle, 27.2 mm
🔗	RIMS	Xposure, aluminium double wall, 26 mm ID, 32H	🏎️	SADDLE	Mongoose Dirt jump, integrated rails
🔗	FRONT HUB	Xposure, aluminium, sealed-bearing, 9 mm x 110 mm, 32H, 6-bolt	🔗	GRIPS	Mongoose Hive, single density
🔗	REAR HUB	Xposure, aluminium, sealed-bearing, 3/8" x 135 mm, 32H, 6-bolt	🏎️	SIZES	One Size
🔗	SPOKES	14G, steel			



FIREBALL 26" UNISEX

WHITE / M29601M200S

	FRAME	Tectonic T1, aluminium, 26" dirt jump geometry, 9 mm x 135 mm dropout, replaceable hanger		SPOKES	146, steel
	FORK	RST DIRT-T, 26", aluminium steerer, 9 mm x 100 mm, thru axle, 100 mm travel		TYRES	Kenda Small Block, 26 in x 2.35 in, wire bead
	CRANK	Samox AF15-D3&S, aluminium, 3&T		PEDALS	Mongoose, nylon
	CHAIN	KMC Z99		BRAKES	Mongoose, mechanical, aluminium, 160 mm rotor
	BOTTOM BRACKET	Samox, cartridge, 3-piece, threaded 68 mm shell		HANDLEBARS	Xposure double-butted, aluminium, 750 mm width, 30 mm rise, 31.8 mm clamp
	REAR COG	Sunrace, 9-speed, 11-3&T		STEM	Xposure melt forged aluminium, threadless, 40 mm, 7°, 31.8 mm clamp
	REAR DERAILLEUR	Shimano Altus RD-M2000		HEADSET	Threadless, ZS44/ZS44, retainer bearing
	RIMS	Xposure, aluminium double wall, 26 mm ID, 32H		SEAT POST	Xposure, aluminium, 201 mm, integrated saddle, 27.2 mm
	FRONT HUB	Xposure, aluminium, ball bearing		SADDLE	Mongoose Dirt jump, integrated rails
	REAR HUB	Xposure, aluminium, ball bearing, 9 mm x 135 mm, 32H, 6-bolt		GRIPS	Mongoose Hive, single density
				SIZES	One Size



mongoose.



CLASICS

CLASICS



HOOLIGAN



HOOLIGAN 29

HOOLIGAN AL 29

SUPERGOOSE



SUPERGOOSE

CALIFORNIA SPECIAL



CALIFORNIA SPECIAL

MINISCOOT II



MINISCOOT II

mongoose.



HOOOLIGAN

Introducing Hooligan - The big BMX for riding the streets like a boss. Durable BMX frame with steel fork and threadless headset are ready to take on whatever you can throw at it. 3-inch wide wheels on aluminum rims provide superior grip and stability while cruising the neighborhood, shredding the urban landscape, and more.





















RIDER
PROFILE

For riders who want to enjoy the thrills of BMX and the efficiency of larger wheels for distance. 29-inch wheels fit riders 162cm to 190cm tall.



HOOLIGAN 29"

BLACK / M30912M20

	FRAME	Hi-Ten steel, horizontal dropout, 1 1/8 in headtube		BRAKES	JAK, mechanical disc, aluminum, 160 mm rotor
	FORK	Mongoose, 29", Hi-Ten steel, 100 mm bolt-on		BRAKE LEVERS	Aluminum
	CRANK	3-piece, tubular chromoly 175 mm, 25T		HANDLEBARS	Mongoose, Hi-Ten steel, 29 in width, 5 in rise
	CHAIN	KMC S1		STEM	Mongoose, threadless top load, 48 mm
	BOTTOM BRACKET	Euro cartridge bearing, 8-spline axle, American, 68 mm shell		HEADSET	Threadless, 1-1/8" external, loose ball bearing
	REAR COG	Single-speed, 13T freewheel		SEAT POST	Aluminum, 250 mm, 20 mm offset, 27.2 mm
	RIMS	Mongoose, aluminum single wall, 35 mm ID, 48H, non tubeless		SADDLE	Mongoose Dirt jump, steel rails
	FRONT HUB	Aluminum, ball bearing, 3/8 in axle, 48H		SIZES	One Size
	REAR HUB	Aluminum, ball bearing, 3/8 in axle, 48H		EXTRAS	QR seat clamp
	TYRES	29 in x 3.0 in, wire bead			
	PEDALS	Mongoose, aluminum			





















BLUE / M30912M10



HOOLIGAN AL 29"

GREEN / M30922M10

	FRAME	6061 aluminum, horizontal dropout, 1 1/8 in headtube
	FORK	Mongoose, 29", Hi-Ten steel, 100 mm bolt-on
	CRANK	3-piece, tubular chromoly 175 mm, 25T
	CHAIN	KMC S1
	BOTTOM BRACKET	Euro cartridge bearing, 8-spline axle, American, 68 mm shell
	REAR COG	Single-speed, 13T freewheel
	RIMS	Mongoose, aluminum single wall, 35 mm ID, 48H, non tubeless
	FRONT HUB	Aluminum, ball bearing, 3/8 in axle, 48H
	REAR HUB	Aluminum, ball bearing, 3/8 in axle, 48H
	TYRES	29 in x 3.0 in, wire bead
	PEDALS	Mongoose, aluminum

	BRAKES	JAK, mechanical disc, aluminum, 160 mm rotor
	BRAKE LEVERS	Aluminum
	HANDLEBARS	Mongoose, Hi-Ten steel, 29 in width, 5 in rise
	STEM	Mongoose, threadless top load, 48 mm
	HEADSET	Threadless, 1-1/8" external, loose ball bearing
	SEAT POST	Aluminum, 250 mm, 20 mm offset, 27.2 mm
	SADDLE	Mongoose Dirt jump, steel rails
	SIZES	One Size
	EXTRAS	QR seat clamp



SILVER / M30922M20



mongoose.



SUPERGOOSE

The Mongoose Supergoose rides again! Modeled after the iconic 1984 Supergoose, this BMX bike is sure to turn heads around the neighborhood or at the track. The new Supergoose offers the same unique Mongoose Pro Class drilled aluminum rims for superior performance that won't weigh you down. The 80's are back, baby – live it up on the iconic Mongoose Supergoose.



Perfect for the classic Mongoose connoisseur looking for durability and ultimate radness.



SUPERGOOSE 20"

BLACK / M40902U100S

△	FRAME	4130 chromoly, horizontal dropout, 1 in headtube
↑	FORK	Mongoose, 20", 4130 chromoly, 100 mm bolt-on
⊕	CRANK	1-piece forged steel, 42T chainring
○	CHAIN	KMC S1
○	BOTTOM BRACKET	American loose ball, loose ball bearing, American, 68 mm shell
▷	REAR COG	Single-speed, 16T freewheel
○	RIMS	Mongoose Pro Class, aluminum single wall, 36H, non tubeless
⊖	FRONT HUB	Aluminum, ball bearing, 3/8 in axle, 36H
⊖	REAR HUB	Aluminum, ball bearing, 3/8 in axle, 36H
✱	SPOKES	140, steel, black

⊖	TYRES	20 in x 1.95 in front; 1.75 in rear, wire bead
⊖	PEDALS	Mongoose, aluminum
⊖	BRAKES	DiaCompe MX1000, caliper, aluminum
└	HANDLEBARS	Mongoose, Hi-Ten steel, 27.5 in width, 8.75 in rise
⊖	STEM	Mongoose, threaded top load, 48 mm
⊖	HEADSET	Threaded, 1" external, loose ball bearing
└	SEAT POST	Steel, 250 mm, 22.2 mm
⊖	SADDLE	Mongoose, steel rails
⊖	GRIPS	Mongoose, classic



RED / M40902U200S

mongoose.

mongoose.



CALIFORNIA SPECIAL

Classic Mongoose fans rejoice - the California Special BMX bike is back! Based on the original 1983 design, the new California Special is great for turning heads around the neighborhood or at the track. It features a Hi-ten steel Mongoose frame built on original geometry of a legend for superior performance and durability.



Perfect for the classic Mongoose connoisseur looking for durability and ultimate radness.



CALIFORNIA SPECIAL 20"

BLACK / M40892U100S

△	FRAME	Hi-Ten steel, horizontal dropout, 1 in headtube	✱	SPOKES	146, steel, chrome
↑	FORK	Mongoose, 20", Hi-Ten steel, 100 mm bolt-on	⌘	TYRES	20 in x 1.75 in, wire bead
⊕	CRANK	1-piece forged steel, 42T chainring	⊕	PEDALS	Mongoose, aluminum
○	CHAIN	KMC S1	⊗	BRAKES	DiaCompe MX1000, caliper, aluminum
⊖	BOTTOM BRACKET	American loose ball, loose ball bearing, American, 68 mm shell	└	HANDLEBARS	Mongoose, Hi-Ten steel, 27.5 in width, 8.75 in rise
└	REAR COG	Single-speed, 16T freewheel	└	STEM	Mongoose, threaded top load, 48 mm
○	RIMS	Mongoose Pro Class, aluminum single wall, 36H, non tubeless	⊕	HEADSET	Threaded, 1" external, loose ball bearing
⊕	FRONT HUB	Aluminum, ball bearing, 3/8 in axle, 36H	└	SEAT POST	Steel, 250 mm, 22.2 mm
⊕	REAR HUB	Aluminum, ball bearing, 3/8 in axle, 36H	└	SADDLE	Mongoose, steel rails
			✱	GRIPS	Mongoose classic



RED / M40892U300S



BLUE / M40892U200S

mongoose.



MINISCOT II

Revel in the 80's awesomeness on this blast-from-the-past freestyle scooter. The Miniscot II features a chromoly frame, 12" x 2.25" air-filled gumwall tyres, Pro Class handlebars, and the classic colors and graphics of the 1987 predecessor. The Miniscot II is still 'the most fun you can have a two feet.





Perfect for the classic Mongoose connoisseur looking for durability and ultimate radness.



MINISCOOT II

BLACK / M40902U100S

 FRAME	4130 Chromoly rails w/ plastic deck	 BRAKES	Aluminum caliper & levers with rotor
 FORK	Steel	 HANDLEBARS	Pro Class Freestyle
 RIMS	Poly mag-style	 STEM	Aluminum top load
 FRONT HUB	Sealed bearings, 3/8" axle	 HEADSET	1" threaded
 REAR HUB	Sealed bearings, 3/8" axle	 GRIPS	110mm mushroom texture
 TYRES	Gumwall 12" x 2.25"		

mongoose.



BMX



BMX

TITLE TEAM RACE



20" TITLE TEAM PRO



20" TITLE TEAM PRO XL



20" TITLE TEAM PRO XXL

TITLE ELITE RACE



24" TITLE ELITE 24



20" TITLE ELITE PRO XL



20" TITLE ELITE PRO XXL

TITLE RACE



24" TITLE 24



20" TITLE PRO



20" TITLE EXPERT



20" TITLE JUNIOR



20" TITLE MINI



20" TITLE MICRO

LEGION FREESTYLE



20" LEGION L500



20" LEGION L100



20" LEGION L80



20" LEGION L60



20" LEGION L40



20" LEGION L20



20" LEGION L10



20" LEGION LXS BOY'S



20" LEGION LXS GIRL'S



18" LEGION L18



16" LEGION L16

mongoose.



TITLE TEAM

In response to the success of the Mongoose Title Elite making its Olympic debut, we've decided to level-up for the more advanced riders out there. Complete with Tectonic T1 biaxial hydroformed and butted aluminium frames, tapered headtube, BB86 press-fit sealed bottom bracket, Disc brake, and 2-pce aluminium crank, the new Title Team is ready to help get you on the podium!

RIDER
PROFILE

The intermediate to advanced BMX racer who wants a lightweight, durable race bike with great spec and won't break the bank.



INTERNAL
CABLE ROUTING



TITLE TEAM PRO XXL 20" UNISEX



















GREY / M42922U100S

 FRAME	Tectonic T1, aluminum biaxial hydroformed and butted, BMX Race geometry, 86 mm press fit BB shell, internal cable routing, 3D Forged, 10 mm dropout, tapered head tube	 TYRES	Arisun XLR8, 20" x 1.75", wire bead
 FORK	BOXX5 carbon, 20", aluminum tapered steerer, 20 mm x 110 mm, thru axle	 PEDALS	Mongoose, nylon
 CRANK	Xposure 2-piece, aluminum 175 mm, 24 mm hollow spindle, 4-arm with 44T chainring	 BRAKES	JAK 7, mechanical disc, aluminum, 140 mm rotor
 CHAIN	KMC S1	 LEVERS	Aluminum
 BOTTOM BRACKET	BB86 press-fit sealed bearing	 HANDLEBARS	Mongoose 4130, 4130 chromoly, 27.5 in width, 8.5 in rise
 REAR COG	Single-speed, 16T cog	 STEM	Mongoose, threadless top load, 50 mm
 RIMS	Xposure Infinity-XR Disc, aluminum double wall, 30 mm ID, 32H front, 36H rear	 HEADSET	Threadless, 1-1/8" sealed integrated, taper compatible
 FRONT HUB	Aluminum, sealed-bearing, 3/8 in bolt, 32H	 SEAT POST	Aluminum, 250 mm, 27.2 mm
 REAR HUB	Aluminum, sealed-bearing cassette, 3/8 in axle, 36H, 6-bolt	 SADDLE	Xposure
		 EXTRAS	QR seat clamp



TITLE TEAM PRO XL 20" UNISEX

GREY / M42912U100S

 FRAME	Tectonic T1, aluminum biaxial hydroformed and butted, BMX Race geometry, 86 mm press fit BB shell, internal cable routing, 3D Forged, 10 mm dropout, tapered headtube	 TYRES	Arisun XLR8, 20" x 1.75", wire bead
 FORK	BOX X5 carbon, 20", aluminum tapered steerer, 20 mm x 110 mm, thru axle	 PEDALS	Mongoose, nylon
 CRANK	Xposure 2-piece, aluminum 175 mm, 24 mm hollow spindle, 4-arm with 44T chainring	 BRAKES	JAK 7, mechanical disc, aluminum, 140 mm rotor
 CHAIN	KMC S1	 LEVERS	Aluminum
 BOTTOM BRACKET	BB86 press-fit sealed bearing	 HANDLEBARS	Mongoose 4130, 4130 chromoly, 27.5 in width, 8.5 in rise
 REAR COG	Single-speed, 16T cog	 STEM	Mongoose, threadless top load, 50 mm
 RIMS	Xposure Infinity-XR Disc, aluminum double wall, 30 mm ID, 32H front, 36H rear	 HEADSET	Threadless, 1-1/8" sealed integrated, taper compatible
 FRONT HUB	Aluminum, sealed-bearing, 3/8 in bolt, 32H	 SEAT POST	Aluminum, 250 mm, 27.2 mm
 REAR HUB	Aluminum, sealed-bearing cassette, 3/8 in axle, 36H, 6-bolt	 SADDLE	Xposure
		 EXTRAS	QR seat clamp



TITLE TEAM PRO 20" UNISEX

GREY / M42912U100S

	FRAME	Tectonic T1, aluminum biaxial hydroformed and butted, BMX Race geometry, 86 mm press fit BB shell, internal cable routing, 3D Forged, 10 mm dropout, tapered head tube		TIRES	Arisun XLR8, 20" x 1.75", wire bead
	FORK	BOXX5 carbon, 20", aluminum tapered steerer, 20 mm x 110 mm, thru axle		PEDALS	Mongoose, nylon
	CRANK	Xposure 2-piece, aluminum 175 mm, 24 mm hollow spindle, 4-arm with 44T chainring		BRAKES	JAK 7, mechanical disc, aluminum, 140 mm rotor
	CHAIN	KMC S1		LEVERS	Aluminum
	BOTTOM BRACKET	BB86 press-fit sealed bearing		HANDLEBARS	Mongoose 4130, 4130 chromoly, 27.5 in width, 8.5 in rise
	REAR COG	Single-speed, 16T cog		STEM	Mongoose, threadless top load, 50 mm
	RIMS	Xposure Infinity-XR Disc, aluminum double wall, 30 mm ID, 32H front, 36H rear		HEADSET	Threadless, 1-1/8" sealed integrated, taper compatible
	FRONT HUB	Aluminum, sealed-bearing, 3/8 in bolt, 32H		SEAT POST	Aluminum, 250 mm, 27.2 mm
	REAR HUB	Aluminum, sealed-bearing cassette, 3/8 in axle, 36H, 6-bolt		SADDLE	Xposure
				EXTRAS	QR seat clamp

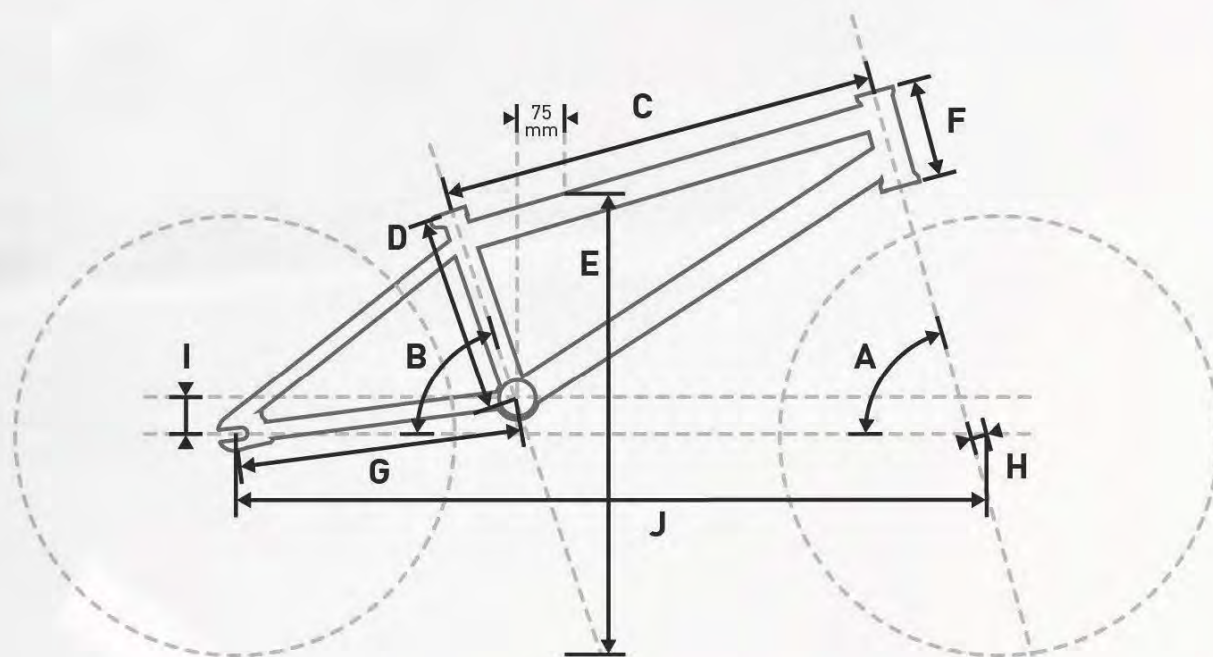

TITLE TEAM

GEOMETRY CHART

	XXL	XL	Pro
A Head Tube Angle (degrees)	74	74	74
B Seat Tube Angle (degrees)	71	71	71
C Horizontal Top Tube Length (mm)	552	540	527
D Seat Tube Length (mm)	233	233	233
E Standover Height (mm)	530	530	530
F Head Tube Length (mm)	120	120	120
G Chainstay Length (mm)	391	364	364
H Fork Offset (mm)	35	35	35
I Bottom Bracket Drop (mm)	38	38	38
J Wheelbase (mm)	975	962	948
Stem Length (mm)	50	50	50
Bar Width (mm)	700	700	700
Seat Post Size (mm)	27.2	27.2	27.2



mongoose.



TITLE ELITE

In response to the success of the Mongoose Title over the past few years, we've decided to level-up for the more advanced riders out there. Complete with Tectonic® T1 biaxial hydroformed and butted aluminum frames, tapered headtube, BB86 press-fit sealed bottom bracket, and 2-piece aluminum crank, the new Title Elite is ready to come out of the gates hot!

RIDER
PROFILE

The intermediate to advanced BMX racer who wants a lightweight, durable race bike with great spec and won't break the bank.





















INTERNAL
CABLE ROUTING



TITLE ELITE 24 24" UNISEX



















BLACK / M42131U100S

 FRAME	Tectonic T1, aluminum biaxial hydroformed and butted, BMX Race geometry, 86mm press fit BB shell, internal cable routing, 3D Forged, 10 mm dropout, tapered head tube	 REAR HUB	Aluminum, sealed-bearing cassette, 3/8 in axle, 36H
 FORK	4130 chromoly	 SPOKES	14G, steel, black
 CRANK	Samox 2-piece, aluminum 175 mm, 24 mm hollow spindle, 4-arm with 42T AL chainring	 TYRES	Arisun XLR8, 24 in x 1.75 in front; 1.75 in rear, wire bead
 CHAIN	KMC S1	 PEDALS	Mongoose, nylon
 BOTTOM BRACKET	BB86 press-fit sealed bearing	 BRAKES	Linear pull, aluminum
 REAR COG	Single-speed, 16T cog	 HANDLEBARS	Mongoose 4130, 4130 chromoly, 28 in width, 6.5 in rise
 RIMS	Xposure Infinity-XD, aluminum double wall, 30 mm ID, 32H front, 36H rear	 STEM	Mongoose, threadless top load, 50 mm
 FRONT HUB	Aluminum, sealed-bearing, 3/8 in bolt, 32H	 HEADSET	Threadless, 1-1/8" sealed integrated, taper compatible
		 SEAT POST	Aluminum, 250 mm, 27.2 mm
		 SADDLE	Mongoose Unifier Pro, 1 piece rails
		 EXTRAS	QR seat clamp



TITLE ELITE PRO XXL 20" UNISEX



















ORANGE / M42121U100S

 FRAME	Tectonic T1, aluminum biaxial hydroformed and butted, BMX Race geometry, 86mm press fit BB shell, internal cable routing, 3D Forged, 10 mm dropout, tapered headtube	 REAR HUB	Aluminum, sealed-bearing cassette, 3/8 in axle, 36H
 FORK	4130 chromoly	 SPOKES	140, steel, black
 CRANK	Samox 2-piece, aluminum 175 mm, 24 mm hollow spindle, 4-arm with 44T chainring	 TYRES	Arisun XLR8, 20 in x 1.95 in front; 1.75 in rear, wire bead
 CHAIN	KMC S1	 PEDALS	Mongoose, nylon
 BOTTOM BRACKET	BB86 press-fit sealed bearing	 BRAKES	Linear pull, aluminum
 REAR COG	Single-speed, 16T cog	 HANDLEBARS	Mongoose 4130, 4130 chromoly, 27.5 in width, 8.5 in rise
 RIMS	Xposure Infinity-XD, aluminum double wall, 30 mm ID, 32H front, 36H rear	 STEM	Mongoose, threadless top load, 50 mm
 FRONT HUB	Aluminum, sealed-bearing, 3/8 in bolt, 32H	 HEADSET	Threadless, 1-1/8" sealed integrated, taper compatible
		 SEAT POST	Aluminum, 250 mm, 27.2 mm
		 SADDLE	Mongoose Unifier Pro, 1 piece rails
		 EXTRAS	QR seat clamp



TITLE ELITE PRO XL 20" UNISEX

ORANGE / M42111U100S

 FRAME	Tectonic T1, aluminum biaxial hydroformed and butted, BMX Race geometry, 86mm press fit BB shell, internal cable routing, 3D Forged, 10 mm dropout, tapered headtube	 REAR HUB	Aluminum, sealed-bearing cassette, 3/8 in axle, 36H
 FORK	4130 chromoly	 SPOKES	14G, steel, black
 CRANK	Samox 2-piece, aluminum 175 mm, 24 mm hollow spindle, 4-arm with 44T chainring	 TYRES	Arisun XLR8, 20 in x 1.95 in front; 1.75 in rear, wire bead
 CHAIN	KMC S1	 PEDALS	Mongoose, nylon
 BOTTOM BRACKET	BB86 press-fit sealed bearing	 BRAKES	Linear pull, aluminum
 REAR COG	Single-speed, 16T cog	 HANDLEBARS	Mongoose 4130, 4130 chromoly, 27.5 in width, 8.5 in rise
 RIMS	Xposure Infinity-XD, aluminum double wall, 30 mm ID, 32H front, 36H rear	 STEM	Mongoose, threadless top load, 50 mm
 FRONT HUB	Aluminum, sealed-bearing, 3/8 in bolt, 32H	 HEADSET	Threadless, 1-1/8" sealed integrated, taper compatible
		 SEAT POST	Aluminum, 250 mm, 27.2 mm
		 SADDLE	Mongoose Unifier Pro, 1 piece rails
		 EXTRAS	QR seat clamp

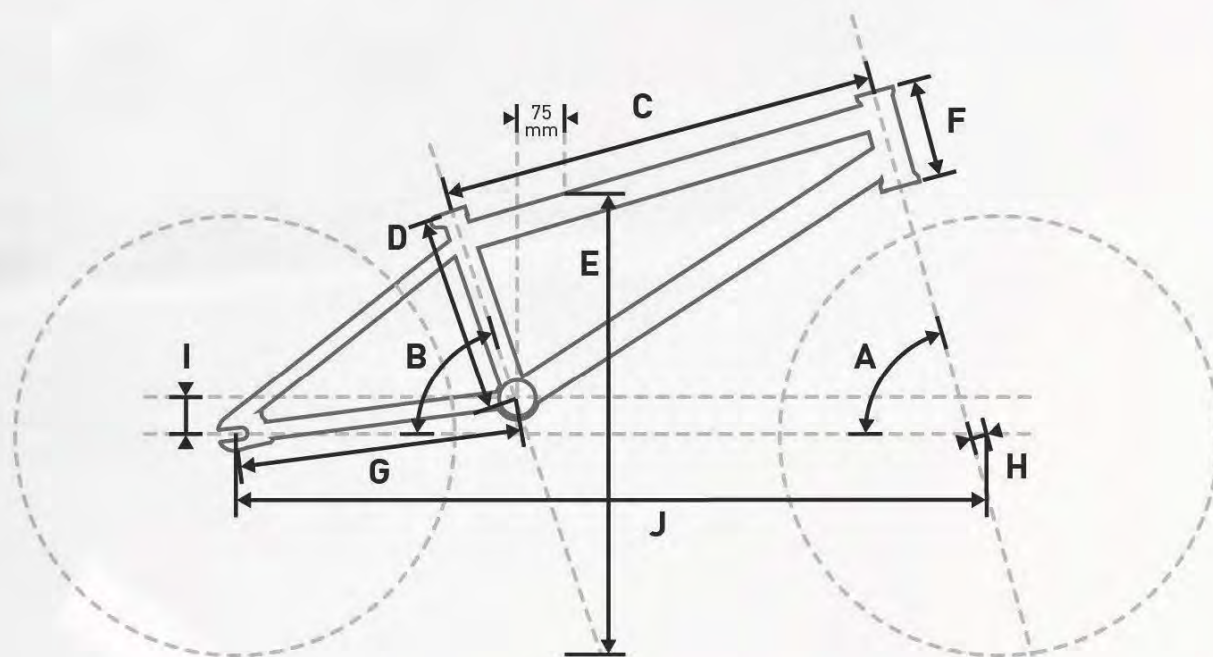

TITLE ELITE

GEOMETRY CHART

	24	XXL	XL
A Head Tube Angle (degrees)	73	74	74
B Seat Tube Angle (degrees)	650	71	71
C Horizontal Top Tube Length (mm)	553	552	540
D Seat Tube Length (mm)	275	233	233
E Standover Height (mm)	600	530	530
F Head Tube Length (mm)	120	120	120
G Chainstay Length (mm)	391	364	364
H Fork Offset (mm)	37	35	35
I Bottom Bracket Drop (mm)	12	38	38
J Wheelbase (mm)	1001	975	960
Stem Length (mm)	50	50	50
Bar Width (mm)	712	700	700
Seat Post Size (mm)	27.2	27.2	27.2



mongoose.



TITLE

Mongoose® was born from BMX race, and the latest Title series bikes have been designed using that same race pedigree. Full Tectonic® aluminum frames with internal cable routing and integrated headsets come together to make a podium worthy bike at an amazingly affordable price.



The entry level BMX racer who wants a lightweight, durable berm burner without spending too much cash.



INTERNAL
CABLE ROUTING



TITLE 24 24" UNISEX



















BLACK / M42532U100S

🔪	FRAME	Tectonic T1, aluminum, BMX Race geometry, internal cable routing, integrated headset	☼	SPOKES	146, steel, chrome
↑	FORK	Hi-Ten steel	🌀	TYRES	Arisun XLR8, 24 in x 1.75 in, wire bead
⚙️	CRANK	3-piece, tubular chromoly 175 mm, 42T chainring	👣	PEDALS	Mongoose, nylon
🔗	CHAIN	KMC S1	🛞	BRAKES	Linear pull, aluminum
🔩	BOTTOM BRACKET	Euro cartridge bearing, 8-spline axle, threaded 68 mm shell	🏴‍☠️	HANDLEBARS	Mongoose, Hi-Ten steel, 27.5 in width, 6.5 in rise
🔩	REAR COG	Single-speed, 18T freewheel	🏴‍☠️	STEM	Mongoose, threadless front load, 48 mm
🔩	RIMS	Xposure Infinity, aluminum double wall, 19 mm ID, 32H front, 36H rear	🏴‍☠️	HEADSET	Threadless, 1-1/8" sealed integrated 41.8, taper compatible
🔩	FRONT HUB	Aluminum, ball bearing, 3/8 in axle, 32H	🏴‍☠️	SEAT POST	Aluminum, 250 mm, 27.2 mm
🔩	REAR HUB	Aluminum, ball bearing, 3/8 in axle, 36H	🏴‍☠️	SADDLE	Mongoose Unifier Pro, 1 piece rails
			🏴‍☠️	EXTRAS	QR seat clamp



TITLE PRO 20" UNISEX

BLACK / M42502U100S

 FRAME	Tectonic T1, aluminum, BMX Race geometry, internal cable routing, integrated headset	 SPOKES	14G, steel, chrome
 FORK	Hi-Ten steel	 TYRES	Arisun XLR8, 20 in x 1.95 in front; 1.75 in rear, wire bead
 CRANK	3-piece, tubular chromoly 175 mm, 44T chainring	 PEDALS	Mongoose, nylon
 CHAIN	KMC S1	 BRAKES	Linear pull, aluminum
 BOTTOM BRACKET	Euro cartridge bearing, 8-spline axle, threaded 68 mm shell	 HANDLEBARS	Mongoose, Hi-Ten steel, 27.5 in width, 8 in rise
 REAR COG	Single-speed, 16T freewheel	 STEM	Mongoose, threadless top load, 50 mm
 RIMS	Xposure Infinity, aluminum double wall, 19 mm ID, 32H front, 36H rear	 HEADSET	Threadless, 1-1/8" sealed integrated 41.8, taper compatible
 FRONT HUB	Aluminum, ball bearing, 3/8 in axle, 32H	 SEAT POST	Aluminum, 250 mm, 27.2 mm
 REAR HUB	Aluminum, ball bearing, 3/8 in axle, 36H	 SADDLE	Mongoose Unifier Pro, 1 piece rails
		 EXTRAS	QR seat clamp



TITLE EXPERT 20" UNISEX

BLACK / M42622U100S

▧	FRAME	Tectonic T1, aluminum, BMX Race geometry, internal cable routing, integrated headset	☼	SPOKES	146, steel, chrome
↑	FORK	Hi-Ten steel	⋈	TYRES	Arisun XLR8, 20 in x 1-3/8 in, wire bead
⚙	CRANK	Samox 3-piece, aluminum 160 mm, 42T chainring	⚙	PEDALS	Mongoose, nylon
🔗	CHAIN	KMC S1	🔗	BRAKES	Linear pull, aluminum
🔗	BOTTOM BRACKET	Euro cartridge bearing, square taper, threaded 68 mm shell	—	HANDLEBARS	Mongoose, aluminum, 26 in width, 6.5 in rise
⚙	REAR COG	Single-speed, 16T freewheel	🔗	STEM	Mongoose, threadless front load, 48 mm
○	RIMS	Xposure Infinity, aluminum double wall, 14 mm ID, 28H	🔗	HEADSET	Threadless, 1-1/8" sealed integrated 41.8, taper compatible
🔗	FRONT HUB	Aluminum, ball bearing, 3/8 in axle, 28H	↑	SEAT POST	Aluminum, 200 mm, 22.2 mm
🔗	REAR HUB	Aluminum, ball bearing, 3/8 in axle, 28H	🔗	SADDLE	Mongoose Unifier Expert, 1 piece rails
			...!	EXTRAS	QR seat clamp



TITLE JUNIOR 20" UNISEX

BLACK / M42632U100S

△	FRAME	Tectonic T1, aluminum, BMX Race geometry, internal cable routing	✳	SPOKES	14G, steel, chrome
↑	FORK	Hi-Ten steel	≡≡≡	TYRES	Arisun XLR8, 20 in x 1-1/8 in, wire bead
⊕	CRANK	Samox 3-piece, aluminum 150 mm, 40T chainring	⊕	PEDALS	Mongoose, nylon
○	CHAIN	KMC S1	⊗	BRAKES	Linear pull, aluminum
⊖	BOTTOM BRACKET	Euro cartridge bearing, square taper, threaded 68 mm shell	┌┐	HANDLEBARS	Mongoose, aluminum, 24 in width, 4 in rise
▶	REAR COG	Single-speed, 16T freewheel	┆	STEM	Mongoose, threadless front load, 30 mm
○	RIMS	Xposure Infinity, aluminum double wall, 14 mm ID, 28H	⊕	HEADSET	Threadless, 1" external, retainer bearing
⊖	FRONT HUB	Aluminum, ball bearing, 3/8 in axle, 28H	┆	SEAT POST	Aluminum, 200 mm, 22.2 mm
⊖	REAR HUB	Aluminum, ball bearing, 3/8 in axle, 28H	∇	SADDLE	Mongoose Unifier Mini, 1 piece rails
			...!	EXTRAS	QR seat clamp



TITLE MINI 20" UNISEX

BLACK / M42612U100S

△	FRAME	Tectonic T1, aluminum, BMX Race geometry, internal cable routing	✳	SPOKES	146, steel, chrome
↑	FORK	Hi-Ten steel	***	TYRES	Arisun XLR8, 20 in x 1-1/8 in, wire bead
⚙	CRANK	Samox 3-piece, aluminum 140 mm, 39T chainring	⚙	PEDALS	Mongoose, nylon
∞	CHAIN	KMC S1	🛞	BRAKES	Linear pull, aluminum
⚙	BOTTOM BRACKET	Euro cartridge bearing, square taper, threaded 68 mm shell	—	HANDLEBARS	Mongoose, aluminum, 22.5 in width, 2.5 in rise
⚙	REAR COG	Single-speed, 16T freewheel	⚙	STEM	Mongoose, threadless front load, 30 mm
○	RIMS	Xposure Infinity, aluminum double wall, 14 mm ID, 28H	🛞	HEADSET	Threadless, 1" external, retainer bearing
⚙	FRONT HUB	Aluminum, ball bearing, 3/8 in axle, 28H		SEAT POST	Aluminum, 200 mm, 22.2 mm
⚙	REAR HUB	Aluminum, ball bearing, 3/8 in axle, 28H	🚲	SADDLE	Mongoose Unifier Mini, 1 piece rails
			...!	EXTRAS	QR seat clamp



TITLE MICRO 20" UNISEX

BLACK / M42602U100S

△	FRAME	Tectonic T1, aluminum, BMX Race geometry, internal cable routing	✳	SPOKES	14G, steel, chrome
↑	FORK	Hi-Ten steel	≡≡≡	TYRES	Kenda, 20 in x 1.25 in, wire bead
⊕	CRANK	Samox 3-piece, aluminum 130 mm, 39T chainring	⊕	PEDALS	Mongoose, nylon
○	CHAIN	KMC S1	⊗	BRAKES	Linear pull, aluminum
◻	BOTTOM BRACKET	Euro cartridge bearing, square taper, threaded 68 mm shell	┌┐	HANDLEBARS	Mongoose, aluminum, 21 in width, 2 in rise
▶	REAR COG	Single-speed, 16T freewheel	┆	STEM	Mongoose, threadless front load, 30 mm
○	RIMS	Xposure Infinity, aluminum double wall, 14 mm ID, 28H	⊗	HEADSET	Threadless, 1" external, retainer bearing
⊕	FRONT HUB	Aluminum, ball bearing, 3/8 in axle, 28H	┆	SEAT POST	Aluminum, 200 mm, 22.2 mm
⊕	REAR HUB	Aluminum, ball bearing, 3/8 in axle, 28H	∇	SADDLE	Mongoose Unifier Mini, 1 piece rails
			...!	EXTRAS	QR seat clamp



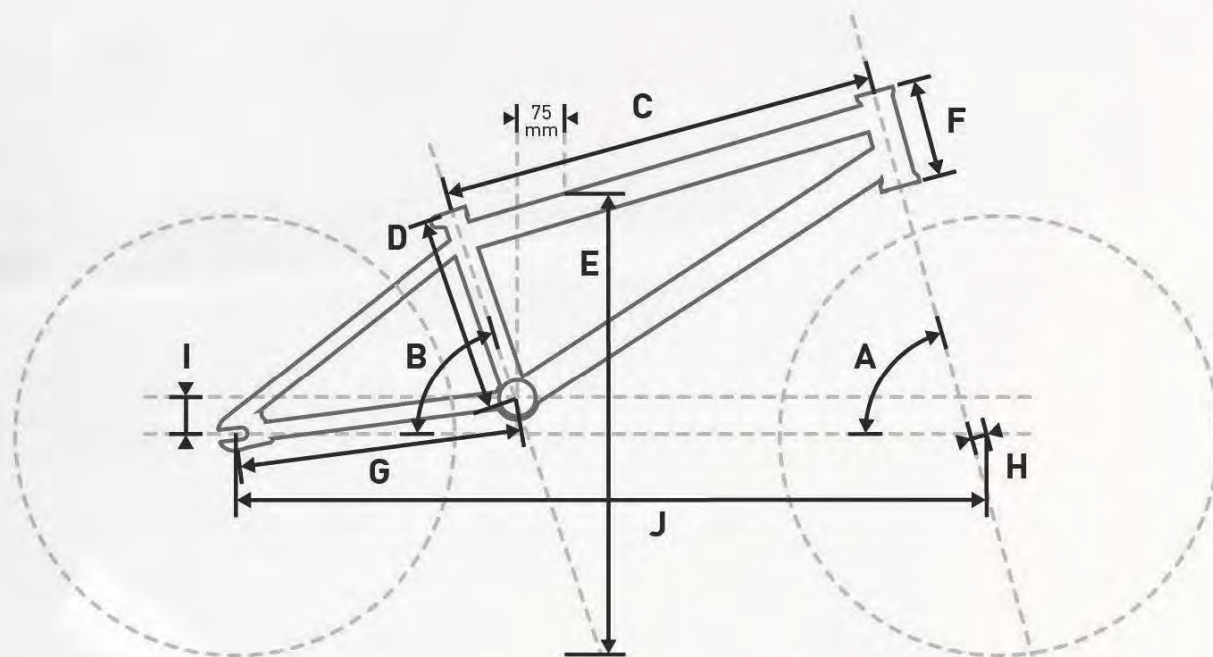

TITLE

GEOMETRY CHART

	24	Pro	Expert	Junior	Mini	Micro
A Head Tube Angle (degrees)	73	74	73	73	73	71
B Seat Tube Angle (degrees)	71	71	71	71	71	70
C Horizontal Top Tube Length (mm)	553	527	495	470	444	419
D Seat Tube Length (mm)	275	233	233	233	220	220
E Standover Height (mm)	600	530	530	510	502	482
F Head Tube Length (mm)	120	120	115	90	90	90
G Chainstay Length (mm)	391	364	345	340	343	330
H Fork Offset (mm)	37	35	34	34	34	34
I Bottom Bracket Drop (mm)	12	38	20	9.5	9.5	0
J Wheelbase (mm)	1001	946	902	863	834	804
Stem Length (mm)	50	50	30	30	30	30
Bar Width (mm)	712	700	660	610	570	530
Seat Post Size (mm)	27.2	27.2	22.2	22.2	22.2	22.2



mongoose.



LEGION

Ranging from the LXS to the L500, the Legion series of bikes offers everything a BMX rider could need from your first true BMX bike in the L18 to a fully park, street and dirt worthy machine in the L500. Mongoose® has infused over 40 years of experience along with feedback and insights from our pro riders to develop the best line of Legion bikes yet.



For the BMX rider who's looking to improve their ability no matter what skill level they're at without breaking the bank.



LEGION L500 20" UNISEX





















BLACK / M41101U100S

▧	FRAME	4130 chromoly, BMX freestyle geometry, removable brake mounts, integrated headset	⌘	TYRES	20 in x 2.4 in, wire bead
↑	FORK	4130 chromoly, 20", 4130 chromoly	⊕	PEDALS	Mongoose, nylon
⊕	CRANK	2-piece, tubular chromoly hollow spindle, 25T aluminium chainring	⊖	BRAKES	U-brake, aluminium
∞	CHAIN	KMC HL1 Halflink	┌	HANDLEBARS	Mongoose, 4130 chromoly, 29 in width, 8.75 in rise
⊖	BOTTOM BRACKET	Mid sealed bearing, Mid sealed bearing, 48-spline spindle	└	STEM	Mongoose, threadless top load, 50 mm
└	REAR COG	Single-speed, 9T cassette freecoaster	⊕	HEADSET	Threadless, integrated 1-1/8", cartridge bearing
○	RIMS	Xposure Infinity-XD, aluminium double wall, 30 mm ID, 36H	┌	SEAT POST	Pivotal, steel, 250 mm, 25.4 mm
⊖	FRONT HUB	Aluminium, sealed-bearing, 3/8 in bolt, 36H	└	SADDLE	Mongoose Pivotal, steel rails
⊖	REAR HUB	Aluminium, sealed-bearing cassette, 14 mm axle, 36H	⊕	GRIPS	Mongoose MushXL, 160 mm
✱	SPOKES	146, steel, black	▮	SIZES	One size



LEGION L100 20" UNISEX

GREY / M41201U200S

	FRAME	4130 chromoly, BMX freestyle geometry, removable brake mounts, integrated headset, mid BB shell		TYRES	20 in x 2.4 in, wire bead
	FORK	4130 chromoly, 20", 4130 chromoly		PEDALS	Mongoose, nylon
	CRANK	2-piece, tubular chromoly hollow spindle, 25T aluminium chainring		BRAKES	U-brake, aluminium
	CHAIN	KMC S1		HANDLEBARS	Mongoose, 4130 chromoly, 29 in width, 8.75 in rise
	BOTTOM BRACKET	Mid sealed bearing, 8-spline spindle		STEM	Mongoose, threadless top load, 50 mm
	REAR COG	Single-speed, 9T cassette driver		HEADSET	Threadless, integrated 1-1/8", cartridge bearing
	RIMS	Xposure Infinity-XD, aluminium double wall, 30 mm ID, 36H		SEAT POST	Pivotal, steel, 250 mm, 25.4 mm
	FRONT HUB	Aluminum, ball bearing, 3/8 in axle, 36H		SADDLE	Mongoose Pivotal
	REAR HUB	Aluminum, sealed-bearing cassette, 14 mm axle, 36H		GRIPS	Mongoose MushXL, 160 mm
	SPOKES	14G, steel, black		SIZES	One size



GREEN / M41201U100S



LEGION L80 20" UNISEX

BLUE / M41301U200S

▧	FRAME	4130 chromoly front triangle, BMX freestyle geometry, integrated headset, mid BB shell
↑	FORK	Hi-Ten steel, 20", Hi-Ten steel
⚙	CRANK	3-piece, tubular chromoly, 25T steel chainring
○	CHAIN	KMC S1
○	BOTTOM BRACKET	Mid sealed bearing, 8-spline spindle
⤴	REAR COG	Single-speed, 9T cassette driver
○	RIMS	Aluminum single wall, 29 mm ID, 36H
⊞	FRONT HUB	Aluminum, ball bearing, 3/8 in axle, 36H
⊞	REAR HUB	Aluminum, sealed-bearing cassette, 14 mm axle, 36H
✳	SPOKES	146, steel, black

⊞	TYRES	20 in x 2.3 in, wire bead
⊞	PEDALS	Mongoose, nylon
⊞	BRAKES	U-brake, aluminium
└	HANDLEBARS	Mongoose, Hi-Ten steel, 29 in width, 9 in rise
⊞	STEM	Mongoose, threadless top load, 50 mm
⊞	HEADSET	Threadless, integrated 1-1/8", cartridge bearing
└	SEAT POST	Pivotal, steel, 250 mm, 25.4 mm
⊞	SADDLE	Mongoose Pivotal
⊞	GRIPS	Mongoose MushXL, 160 mm
⊞	SIZES	One size























TAN / M41301U100S



LEGION L60 20" UNISEX

TEAL / M41401U200S

	FRAME	Hi-Ten steel, BMX freestyle geometry, integrated headset, mid BB shell
	FORK	Hi-Ten steel, 20", Hi-Ten steel
	CRANK	3-piece, tubular chromoly, 25T steel chainring
	CHAIN	KMC S1
	BOTTOM BRACKET	Mid sealed bearing, 8-spline spindle
	REAR COG	Single-speed, 9T cassette driver
	RIMS	Aluminum single wall, 29 mm ID, 36H
	FRONT HUB	Steel, ball bearing, 3/8 in axle, 36H
	REAR HUB	Steel, sealed-bearing cassette, 14 mm axle, 36H
	SPOKES	14G, steel, black

	TYRES	20 in x 2.3 in, wire bead
	PEDALS	Mongoose, nylon
	BRAKES	U-brake, aluminium
	HANDLEBARS	Mongoose, Hi-Ten steel, 29 in width, 8.75 in rise
	STEM	Mongoose, threadless top load, 50 mm
	HEADSET	Threadless, integrated 1-1/8", cartridge bearing
	SEAT POST	Steel, 250 mm, 25.4 mm
	SADDLE	Mongoose Unifier
	GRIPS	Mongoose MushXL, 160 mm
	SIZES	One size



BLUE / M41401U100S



LEGION L40 20" UNISEX

PURPLE / M41501U200S

△	FRAME	Hi-Ten steel, BMX freestyle geometry, mid BB shell
↑	FORK	Hi-Ten steel, 20", Hi-Ten steel
⊕	CRANK	3-piece, tubular chromoly, 25T steel chainring
∅	CHAIN	KMC S1
∅	BOTTOM BRACKET	Mid sealed bearing, 8-spline spindle
⌋	REAR COG	Single-speed, 9T cassette driver
○	RIMS	Aluminum single wall, 24 mm ID, 36H
⊞	FRONT HUB	Steel, ball bearing, 3/8 in axle, 36H
⊞	REAR HUB	Steel, sealed-bearing cassette, 14 mm axle, 36H
✳	SPOKES	140, steel, black

⊞	TYRES	20 in x 2.3 in, wire bead
⊞	PEDALS	Mongoose, nylon
⊞	BRAKES	U-brake, aluminium
└	HANDLEBARS	Mongoose, Hi-Ten steel, 28 in width, 8 in rise
⊞	STEM	Mongoose, threadless top load, 50 mm
⊞	HEADSET	Threadless, integrated 1-1/8", retainer bearing
└	SEAT POST	Steel, 250 mm, 25.4 mm
⊞	SADDLE	Mongoose Unifier
⊞	GRIPS	Mongoose MushXL, 160 mm
⊞	SIZES	One size



BLACK / M41501U100S



LEGION L20 20" UNISEX

WHITE / M41801U100S

▽	FRAME	Hi-Ten steel, BMX freestyle geometry
↑	FORK	Hi-Ten steel, 20", Hi-Ten steel
⊕	CRANK	3-piece, tubular chromoly, 25T steel chainring
∞	CHAIN	KMC S1
⊖	BOTTOM BRACKET	American loose ball, 8-spline spindle
▶	REAR COG	Single-speed, 9T cassette driver
○	RIMS	Aluminum single wall, 24 mm ID, 36H
⊖	FRONT HUB	Steel, ball bearing, 3/8 in axle, 36H
⊖	REAR HUB	Steel, sealed-bearing cassette, 14 mm axle, 36H
✱	SPOKES	140, steel, black

⊖	TYRES	20 in x 2.3 in, wire bead
⊖	PEDALS	Mongoose, nylon
⊖	BRAKES	U-brake, aluminium
┌	HANDLEBARS	Mongoose, Hi-Ten steel, 28 in width, 8 in rise
⊖	STEM	Mongoose, threadless top load, 50 mm
⊖	HEADSET	Threadless, 1-1/8" external, retainer bearing
┌	SEAT POST	Steel, 250 mm, 25.4 mm
⊖	SADDLE	Mongoose, steel rails
⊖	GRIPS	Mongoose Mush, 145 mm
⊖	SIZES	One size



GREEN / M41801U200S



LEGION L10 20" UNISEX

BLACK / M41901U100S

🔗	FRAME	Hi-Ten steel, BMX freestyle geometry	🚴	TYRES	20 in x 2.25 in, wire bead
👤	FORK	Hi-Ten steel, 20", Hi-Ten steel	🦿	PEDALS	Mongoose, nylon
🔗	CRANK	1-piece, forged steel, 25T steel chainring	🛞	BRAKES	U-brake, steel
🔗	CHAIN	KMC S1	👤	HANDLEBARS	Mongoose, Hi-Ten steel, 27.5 in width, 8 in rise
🔗	BOTTOM BRACKET	American loose ball	👤	STEM	Mongoose, threadless front load, 48 mm
🔗	REAR COG	Single-speed, 9T cassette driver	👤	HEADSET	Threadless, 1-1/8" external, retainer bearing
🔗	RIMS	Aluminum single wall, 24 mm ID, 36H	👤	SEAT POST	Steel, 250 mm, 25.4 mm
🔗	FRONT HUB	Steel, ball bearing, 3/8 in axle, 36H	👤	SADDLE	Mongoose, steel rails
🔗	REAR HUB	Steel, sealed-bearing, 3/8 in axle, 36H	👤	GRIPS	Mongoose Mush, 145 mm
🔗	SPOKES	146, steel, black	👤	SIZES	One size



BLUE / M41901U200S



LEGION LXS 20" BOY'S

RED / M51809M500S

▽	FRAME	Hi-Ten steel, BMX geometry	☞	TYRES	20 in x 2.0 in, wire bead
↑	FORK	Hi-Ten steel, 20", steel steerer, 3/8" x 100 mm	⊕	PEDALS	BMX, nylon
⊕	CRANK	1-piece, forged steel, 36T steel chainring	⊗	BRAKES	Linear pull, steel
∅	CHAIN	KMC	┌	HANDLEBARS	Mongoose, Hi-Ten steel, 26 in width, 7 in rise, 22.2 mm clamp
∅	BOTTOM BRACKET	American loose ball, American loose ball	⊥	STEM	Mongoose, threaded top load, 50 mm
▶	REAR COG	16T freewheel, single-speed, 16T	⊕	HEADSET	Threaded, 1" external, ball bearing
○	RIMS	Aluminum single wall, 20 mm ID, 36H	┌	SEAT POST	Steel, 250 mm, 25.4 mm
⊥	FRONT HUB	Steel, ball bearing, 3/8 in axle, 36H	⊥	SADDLE	Mongoose, steel rails
⊥	REAR HUB	Steel, ball bearing, 3/8 in axle, 36H	⊕	GRIPS	Mongoose Zig, 130 mm
✱	SPOKES	140, steel, black	⊥	SIZES	One size



LEGION LXS 20" GIRL'S

WHITE / M41809F400S

△	FRAME	Hi-Ten steel, BMX geometry	▣	TYRES	20 in x 2.0 in, wire bead
↑	FORK	Hi-Ten steel, 20", steel steerer, 3/8" x 100 mm	⊕	PEDALS	BMX, nylon
⊕	CRANK	1-piece, forged steel, 3&T steel chainring	⊗	BRAKES	Linear pull, steel
∞	CHAIN	KMC	└	HANDLEBARS	Mongoose, Hi-Ten steel, 2& in width, 7 in rise, 22.2 mm clamp
⊖	BOTTOM BRACKET	American loose ball, American loose ball	⊥	STEM	Mongoose, threaded top load, 50 mm
└	REAR COG	1&T freewheel, single-speed, 1&T	⊕	HEADSET	Threaded, 1" external, ball bearing
○	RIMS	Aluminum single wall, 20 mm ID, 3&H	└	SEAT POST	Steel, 250 mm, 25.4 mm
⊥	FRONT HUB	Steel, ball bearing, 3/8 in axle, 3&H	⊖	SADDLE	Mongoose, steel rails
⊥	REAR HUB	Steel, ball bearing, 3/8 in axle, 3&H	⊕	GRIPS	Mongoose Zig, 130 mm
✱	SPOKES	14&, steel, black	⊥	SIZES	One size



LEGION L18 18" UNISEX

SILVER / M41700U100S

△	FRAME	Hi-Ten steel, BMX freestyle geometry	≡	TYRES	18 in x 2.3 in, wire bead
↑	FORK	Hi-Ten steel	⊞	PEDALS	Mongoose, nylon
⊕	CRANK	1-piece, forged steel, 25T steel chainring	⊗	BRAKES	U-brake, aluminium
∅	CHAIN	KMC S1	┌┐	HANDLEBARS	Mongoose, Hi-Ten steel, 26 in width, 7 in rise
⊖	BOTTOM BRACKET	American loose ball	┆	STEM	Mongoose, threadless front load, 48 mm
▶	REAR COG	Single-speed, 9T cassette driver	⊗	HEADSET	Threadless, 1-1/8" external, retainer bearing
○	RIMS	Aluminum single wall, 24 mm ID, 28H	┆	SEAT POST	Steel, 250 mm, 25.4 mm
⊞	FRONT HUB	Steel, ball bearing, 3/8 in axle, 28H	⊞	SADDLE	Mongoose, steel rails
⊞	REAR HUB	Steel, ball bearing, 3/8 in axle, 28H	⊞	GRIPS	Mongoose Zig, 130 mm
✱	SPOKES	140, steel, black	≡	SIZES	One size



LEGION L16 16" UNISEX

GREEN / M41600U100S

🔗	FRAME	Hi-Ten steel, BMX freestyle geometry	🌀	TYRES	16 in x 2.3 in, wire bead
↑	FORK	Hi-Ten steel	🚲	PEDALS	Mongoose, nylon
⚙️	CRANK	1-piece, forged steel, 25T steel chainring	🛑	BRAKES	U-brake, aluminium
🔗	CHAIN	KMC S1	—	HANDLEBARS	Mongoose, Hi-Ten steel, 22.5 in width, 6 in rise
🔗	BOTTOM BRACKET	American loose ball	🚲	STEM	Mongoose, threadless front load, 48 mm
🔗	REAR COG	Single-speed, 9T cassette driver	🔗	HEADSET	Threadless, 1-1/8" external, retainer bearing
🔗	RIMS	Aluminum single wall, 24 mm ID, 28H	🚲	SEAT POST	Steel, 250 mm, 25.4 mm
🔗	FRONT HUB	Steel, ball bearing, 3/8 in axle, 28H	🚲	SADDLE	Mongoose, steel rails
🔗	REAR HUB	Steel, ball bearing, 3/8 in axle, 28H	🚲	GRIPS	Mongoose Zig, 130 mm
🔗	SPOKES	140, steel, black	🚲	SIZES	One size

mongoose.

KIDS



W
O
K

CIPHER URBAN



24" UNISEX

SWITCHBACK MOUNTAIN



SWITCHBACK 24



SWITCHBACK 20

ROCKADILE MOUNTAIN



24" BOY'S



20" BOY'S



24" GIRL'S



20" GIRL'S

KIDFIT™ SIDEWALK



20" BOY'S



16" BOY'S



12" BOY'S



20" GIRL'S



16" GIRL'S



12" GIRL'S

mongoose.



CIPHER

The Cipher is designed to be the perfect introductory multi-speed bike for kids. Equipped with aluminium rigid fork, simple gearing, and comfortable larger tires, the Cipher offers kids a lightweight, versatile bike for effortless, fun-filled everyday riding. Available in 24" model.



Young riders looking to transition to a multi-speed bike with larger wheels.



CIPHER 24

BLUE / M55300U100S

 FRAME	Tectonic T1, aluminium, 24" urban geometry, 9 mm x 135 mm dropout, replaceable hanger	 SPOKES	146, stainless steel
 FORK	Mongoose, 24", aluminium steerer, aluminium blades, 9 mm x 100 mm, QR	 TYRES	Kenda K-1153, 24 in x 1.75 in, wire bead
 CRANK	Prowheel PRA-112PP, aluminium, 32T	 PEDALS	Mongoose, nylon
 CHAIN	KMC Z7	 BRAKES	Mongoose, V-brake, aluminium
 BOTTOM BRACKET	Prowheel, cartridge, 3-piece, threaded 68 mm shell	 HANDLEBARS	Xposure, aluminium, 520mm width, 30 mm rise, 25.4 mm clamp
 REAR COG	Shimano, 7-speed, 14-34T	 STEM	Xposure, threadless, 60 mm, 25.4 mm clamp
 RIMS	Xposure XP-163, aluminium single wall, 20 mm ID, 32H, non tubeless	 HEADSET	Threadless, Z544/ZS44, retainer bearing
 FRONT HUB	Xposure, aluminium, ball bearing, 9 mm x 100 mm, 32H	 SEAT POST	Xposure, aluminium, 300 mm, zero offset, 27.2 mm
 REAR HUB	Xposure, aluminium, ball bearing, 9 mm x 135 mm QR, 32H	 SADDLE	Mongoose kids, steel rails
		 GRIPS	Xposure, single density
		 SIZES	One size



SWITCHBACK 24 24" UNISEX

NAVY / M55100U100S

 FRAME	Tectonic T1, aluminium, 24" sport geometry, 9 mm x 135 mm QR dropout, internal cable routing, 9 mm x 135 mm dropout, replaceable hanger	 SPOKES	140, stainless steel
 FORK	Xposure, 24", steel steerer, lockout, 9 mm x 100 mm, QR, 60 mm travel	 TYRES	Xposure MTB, 24 in x 2.1 in, wire bead
 CRANK	Prowheel TM-CY10, aluminium, 3&2/2T	 PEDALS	Mongoose, nylon
 CHAIN	KMC Z8	 BRAKES	Mongoose, mechanical, aluminium, 160 mm rotor
 BOTTOM BRACKET	Feimin FP-B609W, cartridge, 3-piece, threaded 68 mm shell	 HANDLEBARS	Xposure, double-butt aluminium, 680 mm width, 25 mm rise, 31.8 mm clamp
 REAR COG	Sunrace, 8-speed, 11-34t	 STEM	Xposure diecast, threadless, 60 mm, 7°, 31.8 mm clamp
 FRONT DERAILLEUR	Shimano FD-M315, band clamp	 HEADSET	Threadless, ZS44/ZS44, retainer bearing
 REAR DERAILLEUR	Shimano RD-TX800	 SEAT POST	Xposure, aluminium, 350 mm, 20 mm offset, 31.6 mm
 RIMS	Xposure MD-16, aluminium double wall, 19 mm ID, 32H	 SADDLE	Mongoose MTB comfort, steel rails
 FRONT HUB	Xposure, aluminium, ball bearing, 9 mm x 100 mm, 32H, 6-bolt	 GRIPS	Xposure Kraton, single density
 REAR HUB	Xposure, aluminium, ball bearing, 9 mm x 135 mm, 32H, 6-bolt	 SIZES	One size



SWITCHBACK 20 20" UNISEX

BLUE / M55200U100S

 FRAME	Tectonic T1, aluminium, 20" sport geometry, 9 mm x 135 mm QR dropout, internal cable routing, 9 mm x 135 mm dropout, replaceable hanger	 TYRES	Xposure MTB, 20 in x 2.1 in, wire bead
 FORK	Xposure, 24", steel steerer, lockout, 9 mm x 100 mm, QR, 60 mm travel	 PEDALS	Mongoose, nylon
 CRANK	Prowheel PRA-102PP, aluminium, 32T	 BRAKES	Mongoose, mechanical, aluminium, 160 mm rotor
 CHAIN	KMC Z8	 HANDLEBARS	Xposure, double-butt aluminium, 560 mm width, 25 mm rise, 31.8 mm clamp
 BOTTOM BRACKET	Feimin FP-B609W, cartridge, 3-piece, threaded 68 mm shell	 STEM	Xposure diecast, threadless, 70 mm, 7°, 31.8 mm clamp
 REAR COG	Sunrace, 8-speed, 11-34t	 HEADSET	Threadless, ZS44/ZS44, retainer bearing
 REAR DERAILLEUR	Shimano RD-TX800	 SEAT POST	Xposure, aluminium, 350 mm, 20 mm offset, 31.6 mm
 RIMS	Xposure MD-16, aluminium double wall, 19 mm ID, 32H	 SADDLE	Mongoose MTB comfort, steel rails
 FRONT HUB	Xposure, aluminium, ball bearing, 9 mm x 100 mm, 32H, 6-bolt	 GRIPS	Xposure Kraton, single density
 REAR HUB	Xposure, aluminium, ball bearing, 9 mm x 135 mm, 32H, 6-bolt	 SIZES	One size
 SPOKES	14G, stainless steel		

mongoose.



ROCKADILE

Featuring 20" and 24" models, the Rockadile line of youth mountain bikes offers everything young XC rippers could need whether they're just getting into the sport or improving their skills.























Young riders who need a trail worthy mountain bike that's just as at home riding around the neighborhood.



ROCKADILE 24

BLACK / M51101M200S

 FRAME	Tectonic T1, aluminium, 24" sport geometry, internal cable routing, 9 mm x 135 mm dropout, replaceable hanger	 SPOKES	14G, stainless steel
 FORK	Xposure, 24", steel steerer, lockout, 9 mm x 100 mm, QR, 60 mm travel	 TYRES	Mongoose, 24 in x 2.1 in, wire bead
 CRANK	Prowheel A643+, aluminium, 24/34/42T	 PEDALS	Mongoose, nylon
 CHAIN	KMC HV500	 BRAKES	Radius, linear pull, aluminium
 BOTTOM BRACKET	Feimin FP-B609W, cartridge, 3-piece, threaded 68 mm shell	 HANDLEBARS	Mongoose, aluminium, 600 mm width, 30 mm rise, 25.4 mm clamp
 REAR COG	Sunrace, 7-speed, 14-34T	 STEM	Xposure diecast, threadless, 60 mm, 7°, 31.8 mm clamp
 RIMS	Xposure, aluminium double wall, 23 mm ID, 32H	 HEADSET	Threadless, ZS44/ZS44, retainer bearing
 FRONT HUB	Xposure, aluminium, ball bearing, 9 mm x 100mm, 32H, 6-bolt	 SEAT POST	Xposure, aluminium, 350 mm, 20 mm offset, 31.6 mm
 REAR HUB	Xposure, aluminium, ball bearing, 3/8 mm x 135 mm, 32H, 6-bolt	 SADDLE	Mongoose MTB Kids, steel rails
		 GRIPS	Mongoose, single density
		 SIZES	One size























GREEN / M51101M100S



ROCKADILE 24

TEAL / M51101F200S

 FRAME	Tectonic T1, aluminium, 24" sport geometry, internal cable routing, 9 mm x 135 mm dropout, replaceable hanger	 SPOKES	140, stainless steel
 FORK	Xposure, 24", steel steerer, lockout, 9 mm x 100 mm, QR, 60 mm travel	 TYRES	Mongoose, 24 in x 2.1 in, wire bead
 CRANK	Prowheel A643+, aluminium, 24/34/42T	 PEDALS	Mongoose, nylon
 CHAIN	KMC HV500	 BRAKES	Radius, linear pull, aluminium
 BOTTOM BRACKET	Feimin FP-B609W, cartridge, 3-piece, threaded 68 mm shell	 HANDLEBARS	Mongoose, aluminium, 600 mm width, 30 mm rise, 25.4 mm clamp
 REAR COG	Sunrace, 7-speed, 14-34T	 STEM	Xposure diecast, threadless, 60 mm, 7°, 31.8 mm clamp
 RIMS	Xposure, aluminium double wall, 23 mm ID, 32H	 HEADSET	Threadless, ZS44/ZS44, retainer bearing
 FRONT HUB	Xposure, aluminium, ball bearing, 9 mm x 100mm, 32H, 6-bolt	 SEAT POST	Xposure, aluminium, 350 mm, 20 mm offset, 31.6 mm
 REAR HUB	Xposure, aluminium, ball bearing, 3/8 mm x 135 mm, 32H, 6-bolt	 SADDLE	Mongoose MTB Kids, steel rails
		 GRIPS	Mongoose, single density
		 SIZES	One size























PINK / M51101F100S



ROCKADILE 20

GREY / M51201M200S

 FRAME	Tectonic T1, aluminium, 20" sport geometry, internal cable routing, 9 mm x 135 mm dropout, replaceable hanger	 SPOKES	146, stainless steel
 FORK	Xposure, 20", steel steerer, lockout, 9 mm x 100 mm, QR, 60 mm travel	 TYRES	Mongoose, 20 in x 2.1 in, wire bead
 CRANK	Samox SAC30-111P, aluminium, 32T	 PEDALS	Mongoose, nylon
 CHAIN	KMC HV500	 BRAKES	Radius, linear pull, aluminium
 BOTTOM BRACKET	Feimin FP-B609W, cartridge, 3-piece, threaded 68 mm shell	 HANDLEBARS	Mongoose, aluminium, 580 mm width, 30 mm rise, 25.4 mm clamp
 REAR COG	Sunrace, 7-speed, 14-34T	 STEM	Xposure diecast, threadless, 60 mm, 7°, 31.8 mm clamp
 RIMS	Xposure, aluminium double wall, 23 mm ID, 32H	 HEADSET	Threadless, ZS44/ZS44, retainer bearing
 FRONT HUB	Xposure, aluminium, 9 mm x 100mm, 32H, 6-bolt	 SEAT POST	Xposure, aluminium, 350 mm, 20 mm offset, 31.6 mm
 REAR HUB	Xposure, aluminium, ball bearing, 3/8 mm x 135 mm, 32H, 6-bolt	 SADDLE	Mongoose Kids, integrated rails
		 GRIPS	Mongoose, single density
		 SIZES	One size



RED / M51201M100S



ROCKADILE 20

SILVER / M51201F200S

△	FRAME	Tectonic T1, aluminium, 20" sport geometry, internal cable routing, 9 mm x 135 mm dropout, replaceable hanger	✳	SPOKES	140, stainless steel
∪	FORK	Xposure, 20", steel steerer, lockout, 9 mm x 100 mm, QR, 60 mm travel	⌘	TYRES	Mongoose, 20 in x 2.1 in, wire bead
⊕	CRANK	Samox SAC30-111P, aluminium, 32T	⊕	PEDALS	Mongoose, nylon
○	CHAIN	KMC HV500	⊖	BRAKES	Radius, linear pull, aluminium
⊖	BOTTOM BRACKET	Feimin FP-B609W, cartridge, 3-piece, threaded 68 mm shell	└	HANDLEBARS	Mongoose, aluminium, 580 mm width, 30 mm rise, 25.4 mm clamp
▶	REAR COG	Sunrace, 7-speed, 14-34T	└	STEM	Xposure diecast, threadless, 60 mm, 7°, 31.8 mm clamp
○	RIMS	Xposure, aluminium double wall, 23 mm ID, 32H	⊕	HEADSET	Threadless, ZS44/ZS44, retainer bearing
⊖	FRONT HUB	Xposure, aluminium, 9 mm x 100mm, 32H, 6-bolt	└	SEAT POST	Xposure, aluminium, 350 mm, 20 mm offset, 31.6 mm
⊖	REAR HUB	Xposure, aluminium, ball bearing, 3/8 mm x 135 mm, 32H, 6-bolt	∪	SADDLE	Mongoose Kids, integrated rails
			✋	GRIPS	Mongoose, single density
			⊖	SIZES	One size



PURPLE / M51201F100S



KIDFIT





Lower seat position for better balance and maneuverability

Lightweight frame with forward pedal position to make pedaling easier

Smaller grips designed to fit kids hands

Narrower crank and pedal positions to match the width of kids hips allow for a stronger, more natural pedal stroke

KIDFIT™

Featured on: Racer X, LadyGoose, MityGoose, MissyGoose, LilGoose

- › **Easier pedaling**
- › **Improved positioning**
- › **Increased acceleration**

BIKES BUILT FOR KIDS

Before they hit the trail or pull any tricks, kids have to learn to ride - but it can be tough. Traditionally, kids' bikes are just scaled-down versions of adult bikes. This doesn't take proper fit or pedaling mechanics into consideration.

To tackle this problem, Mongoose® has developed a new line of KidFit™ bikes which are designed specifically for the next generation of trail slayers. Narrower cranks, a more kid-friendly geometry, optimized gearing and smaller touch points are all optimized to build confidence for kids. Plus, the bikes will fit growing kids for a longer time. All of this combines to create the ride fit just for a kid!



RACER X

SILVER / M55107M600S

▽	FRAME	Tectonic T1, aluminium, 20" kids geometry, 100 mm dropout	⌘	TYRES	Mongoose, 20 in x 2.125 in, wire bead
∧	FORK	Mongoose, 20", steel steerer, 100 mm, bolt-on	⊕	PEDALS	Kids, plastic
⊕	CRANK	Mongoose 1-piece narrow Q-factor, 32T	⊖	BRAKES	Aluminum caliper front, rear steel coaster brake
⊖	CHAIN	KMC Z410	—	HANDLEBARS	Mongoose, Hi-Ten steel, 580 mm width, 17½ mm rise, 22.2 mm clamp
⊖	BOTTOM BRACKET	Internal, 1-piece, American, 68 mm shell	⊖	STEM	Aluminum/steel, quill, 50 mm ext., 22.2 mm clamp
▶	REAR COG	Single-speed, 16T	⊖	HEADSET	Threaded, EC22.2/27, retainer bearing
○	RIMS	Aluminum single wall, 28H	—	SEAT POST	Steel, 250 mm, integrated saddle, 27.2 mm
⊖	FRONT HUB	Steel, 3/8 in axle, 28H	⊖	SADDLE	Mongoose Kids, integrated rails
⊖	REAR HUB	Steel, 3/8 in axle, 28H, coaster brake	⊖	GRIPS	Mongoose, kids
✱	SPOKES	140, stainless steel	⊖	SIZES	One size



RED / M55107M100S



LADYGOOSE

TEAL / M55107F200S

🔗	FRAME	Tectonic T1, aluminium, 20" kids geometry, 100 mm dropout
🏍️	FORK	Mongoose, 20", steel steerer, 100 mm, bolt-on
🔩	CRANK	Mongoose 1-piece narrow Q-factor, 32T
🔗	CHAIN	KMC Z410
🔩	BOTTOM BRACKET	Internal, 1-piece, American, 68 mm shell
⚙️	REAR COG	Single-speed, 16T
🔗	RIMS	Aluminum single wall, 28H
🔩	FRONT HUB	Steel, 3/8 in axle, 28H
🔩	REAR HUB	Steel, 3/8 in axle, 28H, coaster brake
🌟	SPOKES	140, stainless steel

🔗	TYRES	Mongoose, 20 in x 2.125 in, wire bead
🔩	PEDAL	Kids, plastic
🔩	BRAKES	Aluminum caliper front, rear steel coaster brake
🏍️	HANDLEBARS	Mongoose, Hi-Ten steel, 580 mm width, 176 mm rise, 22.2 mm clamp
🔩	STEM	Aluminum/steel, quill, 50 mm ext., 22.2 mm clamp
🔩	HEADSET	Threaded, EC22.2/27, retainer bearing
🔩	SEAT POST	Steel, 250 mm, integrated saddle, 27.2 mm
🔩	SADDLE	Mongoose Kids, integrated rails
🔩	GRIPS	Mongoose, kids
🔩	SIZES	One size



PURPLE / M55107F950S



MITYGOOSE

BLUE / M55207M200S

▽	FRAME	Tectonic T1, aluminum, 16" kids geometry, 100 mm dropout	⌘	TYRES	Mongoose, 16 in x 2.125 in, wire bead
┆	FORK	Mongoose, 16", steel steerer, 100 mm, bolt-on	⊕	PEDALS	Kids, plastic
⊕	CRANK	1-piece forged steel 89 mm, 28T steel chainring	⊖	BRAKES	Aluminum caliper front, rear steel coaster brake
⊖	CHAIN	KMC Z410	┆	HANDLEBARS	Mongoose, Hi-Ten steel, 500 mm width, 130 mm rise, 22.2 mm clamp
⊖	BOTTOM BRACKET	Internal, 1-piece, American, 68 mm shell	┆	STEM	Aluminum/steel, quill, 30 mm ext., 22.2 mm clamp
┆	REAR COG	Single-speed, 16T	⊕	HEADSET	Threaded, EC22.2/27, retainer bearing
⊖	RIMS	Aluminum single wall, 20H	┆	SEAT POST	Aluminum, integrated saddle, 25.4 mm
⊖	FRONT HUB	Steel, 3/8 in axle, 20H	┆	SADDLE	Mongoose Kids, integrated rails
┆	REAR HUB	Steel, 3/8 in axle, 20H, coaster brake	┆	GRIPS	Mongoose, kids
⊕	SPOKES	140, stainless steel	┆	SIZES	One size



GREEN / M55207M300S



SILVER / M55207M600S



RED / M55207M500S



MISSYGOOSE

BLUE / M55207F200S

🔗	FRAME	Tectonic T1, aluminium, 16" kids geometry, 100 mm dropout
🏍️	FORK	Mongoose, 16", steel steerer, 100 mm, bolt-on
🔩	CRANK	1-piece forged steel 89 mm, 24T steel chainring
🔗	CHAIN	KMC Z410
🔩	BOTTOM BRACKET	Internal, 1-piece, American, 68 mm shell
⚙️	REAR COG	Single-speed, 16T
🔗	RIMS	Aluminum single wall, 16H
🔩	FRONT HUB	Steel, 3/8 in axle, 16H
🔩	REAR HUB	Steel, 3/8 in axle, 16H, coaster brake
🌟	SPOKES	140, stainless steel

🌟	TYRES	Mongoose, 16 in x 2.125 in, wire bead
🔩	PEDAL	Kids, plastic
🔩	BRAKES	Aluminum caliper front, rear steel coaster brake
🏍️	HANDLEBARS	Mongoose, Hi-Ten steel, 500 mm width, 130 mm rise, 22.2 mm clamp
🔩	STEM	Aluminum/steel, quill, 30 mm ext., 22.2 mm clamp
🔩	HEADSET	Threaded, EC22.2/27, retainer bearing
🏍️	SEAT POST	Aluminum, integrated saddle, 25.4 mm
🔩	SADDLE	Mongoose Kids, integrated rails
🔩	GRIPS	Mongoose, kids
🔩	SIZES	One size



PINK / M55207F900S



PURPLE / M55207F950S



LIL GOOSE

BLACK / M55307M100S

▽	FRAME	Tectonic T1, aluminium, 12" kids geometry, 100 mm dropout
∩	FORK	Mongoose, 12", steel steerer, 100 mm, bolt-on
⊕	CRANK	1-piece forged steel 89 mm, 24T steel chainring
⊖	CHAIN	KMC Z410
⊖	BOTTOM BRACKET	Internal, 1-piece, American, 68 mm shell
▶	REAR COG	Single-speed, 16T
○	RIMS	Aluminum single wall, 16H
⊖	FRONT HUB	Steel, 3/8 in axle, 16H
⊖	REAR HUB	Steel, 3/8 in axle, 16H, coaster brake
✱	SPOKES	140, stainless steel

⊖	TYRES	Mongoose, 12 in x 2.125 in, wire bead
⊖	PEDALS	Kids, plastic
⊖	BRAKES	Aluminum caliper front, rear steel coaster brake
—	HANDLEBARS	Mongoose, Hi-Ten steel, 500 mm width, 130 mm rise, 22.2 mm clamp
⊖	STEM	Aluminum/steel, quill, 30 mm ext., 22.2 mm clamp
⊖	HEADSET	Threaded, EC22.2/27, retainer bearing
—	SEAT POST	Aluminum, integrated saddle, 25.4 mm
⊖	SADDLE	Mongoose Kids, integrated rails
⊖	GRIPS	Mongoose, kids
⊖	SIZES	One size



BLUE / M55307M200S



SILVER / M55307M600S



LIL GOOSE

PURPLE / M55307F950S

🔪	FRAME	Tectonic T1, aluminium, 12" kids geometry, 100 mm dropout
🏍	FORK	Mongoose, 12", steel steerer, 100 mm, bolt-on
🔩	CRANK	1-piece forged steel 89 mm, 24T steel chainring
🔗	CHAIN	KMC Z410
🔩	BOTTOM BRACKET	Internal, 1-piece, American, 68 mm shell
⚙	REAR COG	Single-speed, 16T
🔩	RIMS	Aluminum single wall, 16H
🔩	FRONT HUB	Steel, 3/8 in axle, 16H
🔩	REAR HUB	Steel, 3/8 in axle, 16H, coaster brake
🌟	SPOKES	140, stainless steel

🛞	TYRES	Mongoose, 12 in x 2.125 in, wire bead
🔩	PEDALS	Kids, plastic
🔩	BRAKES	Aluminum caliper front, rear steel coaster brake
🔩	HANDLEBARS	Mongoose, Hi-Ten steel, 500 mm width, 130 mm rise, 22.2 mm clamp
🔩	STEM	Aluminum/steel, 30 mm ext., 22.2 mm clamp
🔩	HEADSET	Threaded, EC22.2/27, retainer bearing
🔩	SEAT POST	Aluminum, integrated saddle, 25.4 mm
🔩	SADDLE	Mongoose Kids, integrated rails
🔩	GRIPS	Mongoose, kids
🔩	SIZES	One size



PINK / M55307F900S



BLUE / M55307F200S

mongoose.



SCOOTERS



Miniscoot II

Retro rides again – the Mongoose Miniscoot II has arrived. This blast-from-the-past scooter was inspired by the iconic 1987 Mongoose Miniscoot, and it's ready to add to your collection. It features durable Chromoly frame, Pro Class freestyle handlebars, and classic 80s colors and graphics. White gumwall tyres on mag wheels provide a smooth, stylish ride – the Miniscoot II is still "the most fun you can have on two feet."



TEAL / MMR6194



Hot 80s Laguna Blue color with electric pink graphics add to the retro vibes.



12" x 2.25" gumwall tyres mounted to sealed bearing poly mag wheels provide a smooth ride.



Alloy caliper hand brakes with freestyle rotor puts reliable speed control at your fingertips.



Durable 4130 Chromoly frame with kicktail deck will stand up to all your throwback radness.



Inspired by the iconic 1987 Mongoose Miniscoot. Great for riders aged 8+, up to 175 lbs/79kg.

TREAD PRO

Take that ride off-road with the Tread Freestyle Dirt Scooter. Built for riding on dirt and gravel, the Tread features a 21 x 5" alloy deck and steel handlebar for maximum durability. The triple anodized clamp collar and threaded headset offer precise, crisp steering, while the steel foot brake delivers controlled stopping power. Plus, large 200 mm air filled tyres with ABEC-7 bearings provide a smooth, stable ride. Get dirty with the Tread scooter.



BLUE / MM6185



200mm air filled tyres with alloy core wheels and ABEC-9 bearings for a smooth, stable ride.



Steel foot brake delivers controlled stopping power.



24" wide chromoly steel handlebar with 165mm rubber grips provide durability and comfort.



Quadruple anodized clamp collar and threadless headset offer precise, crisp steering.

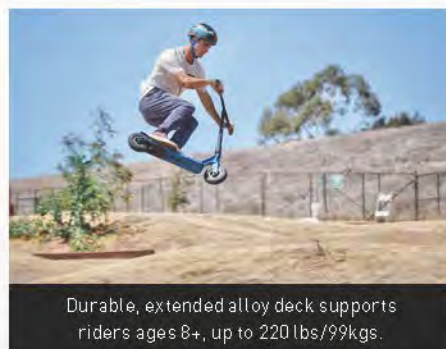

Durable, extended alloy deck supports riders ages 8+, up to 220 lbs/99kgs.

TREAD

Take that ride off-road with the Tread Freestyle Dirt Scooter. Built for riding on dirt and gravel, the Tread features a 21 x 5" alloy deck and steel handlebar for maximum durability. The triple anodized clamp collar and threaded headset offer precise, crisp steering, while the steel foot brake delivers controlled stopping power. Plus, large 200 mm air filled tyres with ABEC-7 bearings provide a smooth, stable ride. Get dirty with the Tread scooter.

BLACK / MM6184



Freestyle scooter built for riding on dirt and gravel.

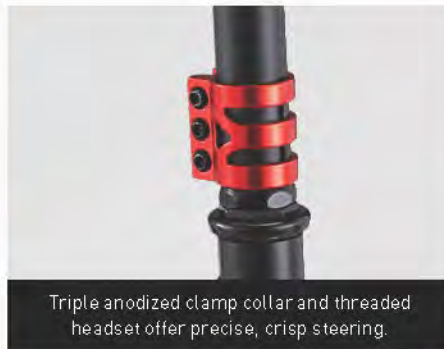

Triple anodized clamp collar and threaded headset offer precise, crisp steering.



20-inch wide steel handlebar with 145 mm rubber grips provide durability and comfort.

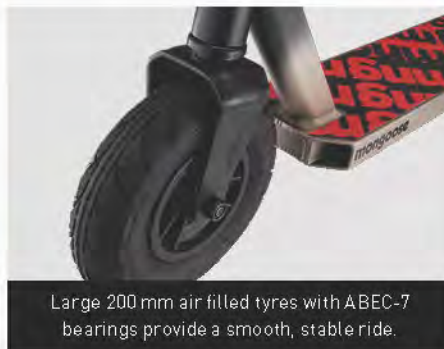

Large 200 mm air filled tyres with ABEC-7 bearings provide a smooth, stable ride.



Durable, extended alloy deck supports riders ages 8+, up to 220 lbs/99kgs.



TRACE AIR

Fly down the street on a rad ride with the Trace Air Scooter by Mongoose. The Trace Air Scooter features 12-inch air filled tires for a smooth ride on both paved and unpaved surfaces. The wide foot deck that provides extra balance and stability while coasting, while the caliper hand brake delivers confident speed control. Plus, the adjustable height stem fits a wide range of riders. Have a blast with the Trace Air Scooter.



TRACE AIR

MMR6331AZ
MMR6331AZA

SPECIFICATIONS

SUGGESTED RIDER AGE	8 Years old and up
MAXIMUM RIDER WEIGHT	Up to 220lbs/99kg
REAR FOOT BRAKE	Front Calliper Hand Brake
KICKSTACK INCLUDED	
WHEEL SIZE AND TYPE	12" Air Filled Rubber Tyres
BEARING TYPE	ABEC-7 bearings
HANDLEBAR GRIP TYPE	BMX Bike Style
HANDLEBAR HEIGHT RANGE	NA
AVAILABLE COLOURS	Silver Black

TRACE AIR

Mongoose 12 Trace Air Scooter fits one rider ages 8 and up with a maximum weight of 220 lbs. Perfect for rad rides around the neighbourhood. Wide foot deck provides balance and stability while coasting. Calliper hand brake delivers confident speed control. Adjustable height stem fits a wide range of riders. 12-Inch air filled tires provide a smooth ride on both paved and unpaved surfaces.



SILVER / MMR6331AZ
BLACK / MMR6331AZA



Fits one rider ages 8 and up with a maximum weight of 99kgs.



Wide foot deck provides balance and stability while coasting.



Adjustable height stem fits a wide range of riders.



Calliper hand brake delivers confident speed control.



12-Inch air filled tires provide a smooth ride on both paved and unpaved surfaces.

RISE

Featuring models for every experience level, the Rise Freestyle Scooters deliver a high-quality ride with a stylish look. Whether you want to show off at the skate park or just ride around town, these durable, lightweight scooters can take whatever you throw at them. Epic adventures await with a Rise Freestyle Scooter. Become your own legend with Mongoose.



MODELS	MM6317AINT MM6317INT	MM6316AINT MM6316INT	MM6315AINT MM6315INT	MM6314AINT MM6314INT SE - MM6314AZB	MM6313AINT MM6313INT
---------------	-------------------------	-------------------------	-------------------------	---	-------------------------

SPECIFICATIONS

SUGGESTED RIDER AGE	8 Years old and up	8 Years old and up	8 Years old and up	8 Years old and up	8 Years old and up
MAXIMUM RIDER WEIGHT	Up to 220lbs/99kg	Up to 220lbs/99kg	Up to 220lbs/99kg	Up to 220lbs/99kg	Up to 220lbs/99kg
REAR FOOT BRAKE	✓	✓	✓	✓	✓
PEGS INCLUDED			✓	✓	
WHEEL SIZE AND TYPE	100mm high impact alloy wheels	100mm high impact alloy wheels	100mm high impact alloy wheels	100mm high impact alloy wheels	100mm high impact plastic wheels
BEARING TYPE	ABEC-9 bearings	ABEC-9 bearings	ABEC-7 bearings	ABEC-7 bearings	ABEC-7 bearings
HANDLEBAR TYPE	One-piece welded alloy T-bar	One-piece welded steel T-bar	One-piece welded steel T-bar	One-piece welded steel T-bar	One-piece welded steel T-bar
HANDLEBAR DIMENSIONS	610 x 610cm	603 x 603cm	584 x 603cm	540 x 578cm	559 x 559cm
CLAMP COLLAR	Quadruple anodised CNC clamp collar	Triple anodised CNC clamp collar	Triple anodised CNC clamp collar	Quadruple anodised clamp collar	Triple anodised clamp collar
AVAILABLE COLOURS	Silver/Blue Purple	Teal/Black Black/Tan	Blue/Yellow Grey/Orange	Black/Red Black/Green SE - Oil Slick	Orange/Blue White/Red

RISE 110 TEAM

With the Rise series, Mongoose offers pro-level, stylish complete freestyle scooters for the best value on the market! Our highest end model, the Rise 110 Team Freestyle Scooter, is loaded with outstanding features, including a lightweight alloy deck with extended standing area, quadruple anodised CNC clamp collar, internal sealed threadless headset, and CNC alloy fork. Stand out at the stakepark with the Rise 110 Team.

SILVER/BLUE / MM6317INT
PURPLE / MM6317AINT

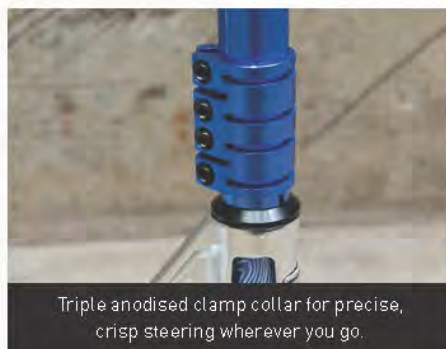
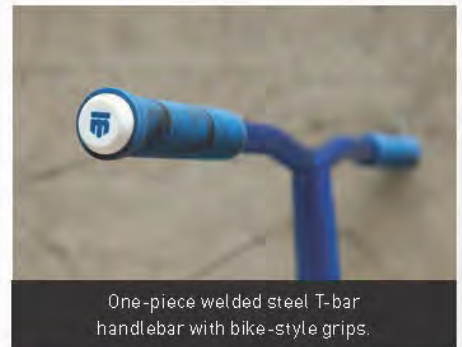

RISE 110 EXPERT

The Mongoose Rise Series of freestyle scooters offer high-end performance at an amazing price! The Rise 110 Expert Freestyle Scooter is loaded with outstanding features, including a lightweight alloy deck, 110 mm high impact alloy wheels, durable ABEC-9 bearings, triple anodised CNC clamp collar, internal sealed threadless headset, and CNC alloy fork. Shred the skatepark with the Rise 110 Expert!



TEAL/BLACK / MM6316AINT
BLACK/TAN / MM6316INT

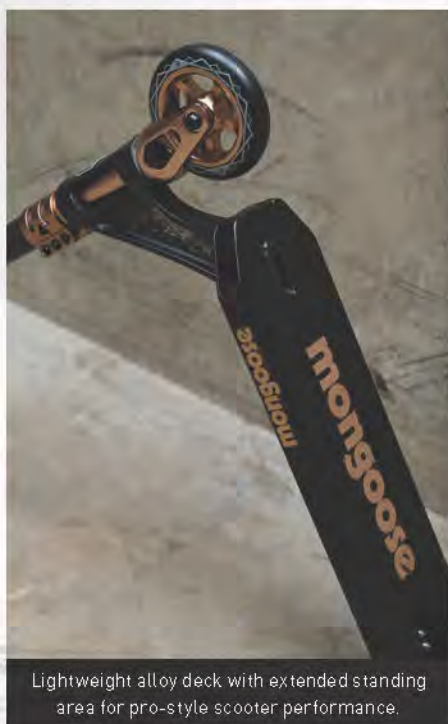

Lightweight alloy deck with extended standing area for pro-style scooter performance.



Alloy deck and steel brake, and 100 mm high impact wheels and durable ABEC-7 bearings.

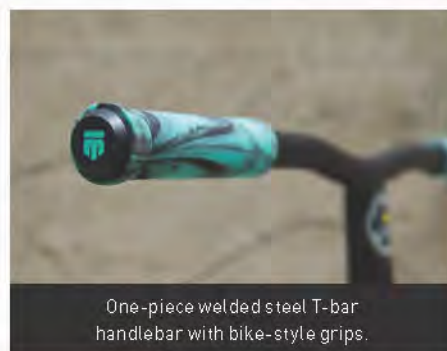

One-piece welded steel T-bar handlebar with bike-style grips.

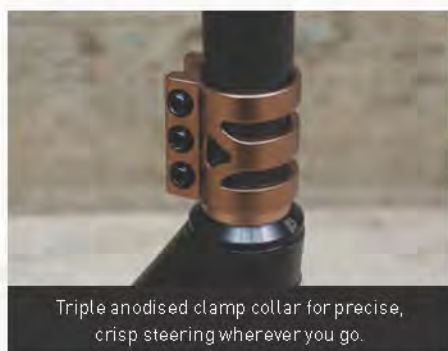

Triple anodised clamp collar for precise, crisp steering wherever you go.

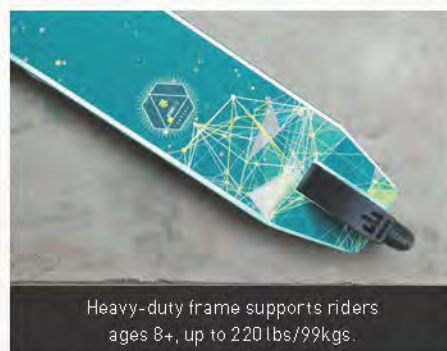

Heavy-duty frame supports riders ages 8+, up to 220 lbs/99kgs.

RISE 110 ELITE

Featuring models for every experience level, the Rise Series of freestyle scooters deliver a high-quality ride with a stylish look! The Rise 110 Elite is loaded with outstanding features, including a lightweight alloy deck, triple anodised CNC clamp collar, internal sealed threadless headset, and alloy fork. Showcase your skills at the skatepark with the 110 Elite!

BLUE/YELLOW / MM&3151NT
GREY/ORANGE / MM&315AINT

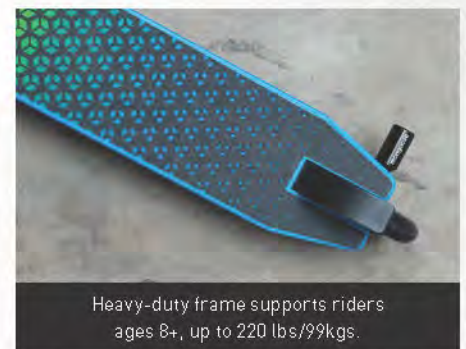
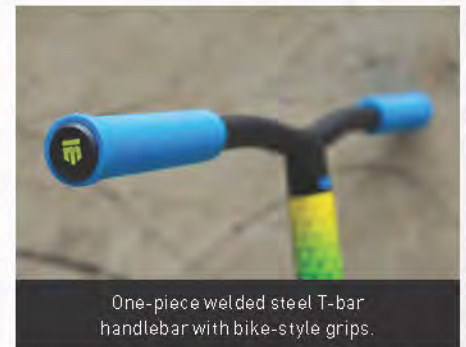

RISE 100 PRO SE

Shred the skatepark in style with the Rise 100 Pro Special Edition Freestyle Scooter in this awesome Oil Slick colourway! The Rise is loaded with outstanding features, including a lightweight alloy deck, quadruple anodised clamp collar, threadless headset, and front and rear alloy pegs for pro-style park performance.

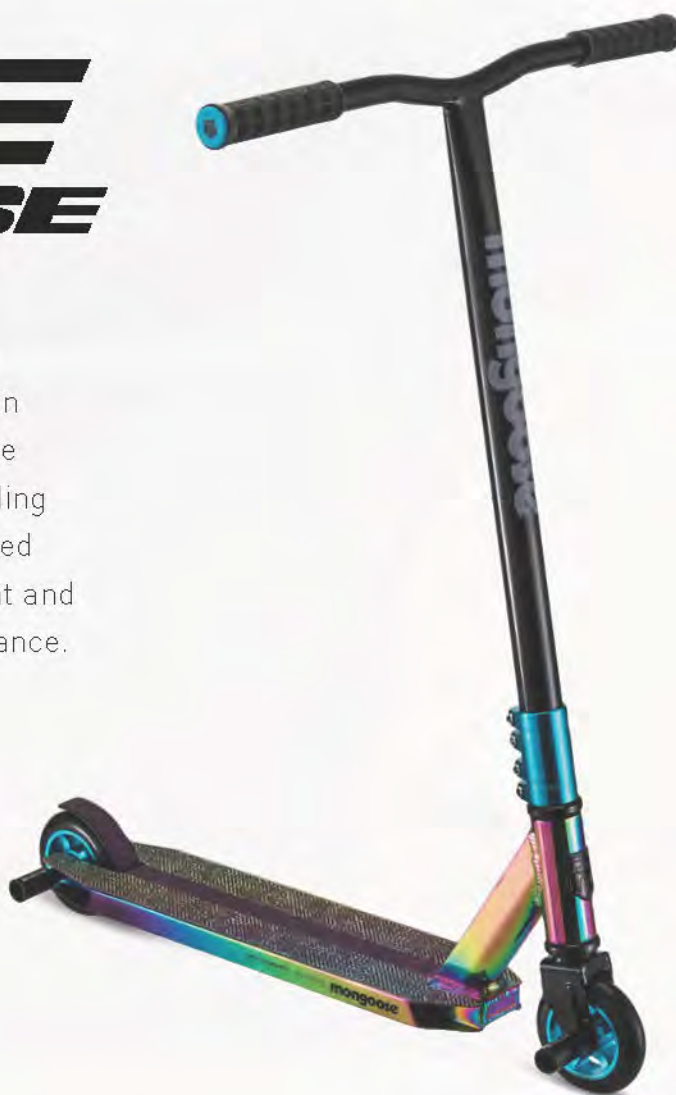

LIMITED EDITION
OIL SLICK / MM6314AZB

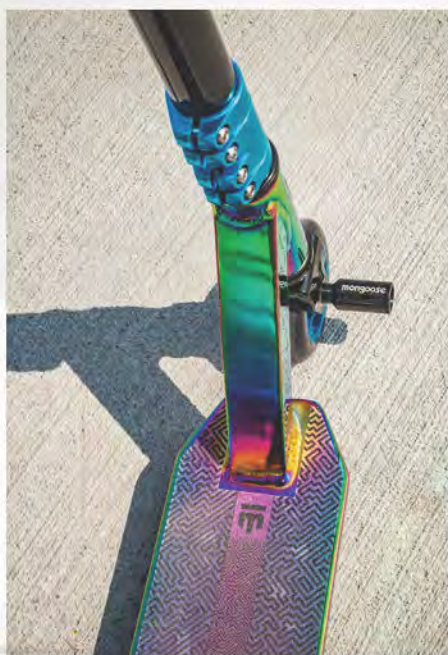

Lightweight alloy deck with extended standing area and front and rear alloy pegs.



Alloy deck and steel brake, and 100 mm high impact wheels and durable ABEC-7 bearings.



One-piece welded steel T-bar handlebar with bike-style grips.



Quadruple anodised clamp collar with threadless headset for precise, crisp steering.



Heavy-duty frame supports riders ages 8+, up to 220 lbs/99kgs.

RISE 100 PRO

Shred the skatepark with the Rise 100 Pro Freestyle Scooter by Mongoose! The Rise is loaded with outstanding features, including a lightweight alloy deck, quadruple anodised clamp collar, threadless headset, and front and rear alloy pegs for pro-style park performance.

BLACK/RED / MM6314INT
BLACK/GREEN / MM6314AINT



Lightweight alloy deck with extended standing area and front and rear alloy pegs.



Alloy deck and steel brake, and 100 mm high impact wheels and durable ABEC-7 bearings.

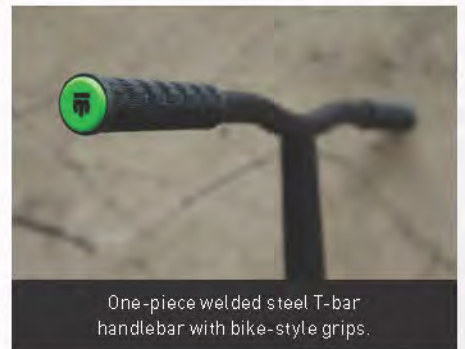

One-piece welded steel T-bar handlebar with bike-style grips.



Quadruple anodised clamp collar with threadless headset for precise, crisp steering.



Heavy-duty frame supports riders ages 8+, up to 220 lbs/99kgs.

RISE 100

Get ready for the skatepark with the Rise 100 Freestyle Scooter by Mongoose. The Rise is loaded with outstanding features, including a lightweight alloy deck, triple anodised clamp collar, and durable ABEC-7 bearings. Upgrade your scooter game with the Rise 100 Freestyle Scooter.



WHITE/RED / MM6313AINT
ORANGE/BLUE / MM6313INT



Lightweight alloy deck with extended standing area for pro-style scooter performance.



Alloy deck and steel brake, and 100 mm high impact wheels and durable ABEC-7 bearings.

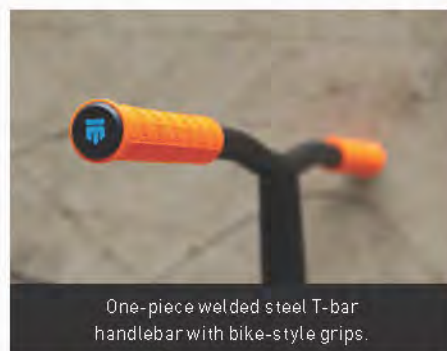

One-piece welded steel T-bar handlebar with bike-style grips.



Triple anodised clamp collar for precise, crisp steering wherever you go.



Heavy-duty frame supports riders ages 8+, up to 220 lbs/99kgs.

TRACE

Have a blast while honing your mad scooter skills with the Trace Folding Scooter series by Mongoose. Trace scooters feature Full-coverage MaxGrip on the lightweight alloy deck and steel brake to ensure a secure, stable ride, while soft foam grips offer comfortable handling. Get performance, convenience, and fun with the Trace Freestyle Kick Scooter series. There's nothing you can't do on a Mongoose.



TRACE 100



TRACE 180

MODELS

MMR6103AZ

MMR6110AZ

SPECIFICATIONS

SUGGESTED RIDER AGE	5 Years Old and Up	8 Years old and up
MAXIMUM RIDER WEIGHT	Up to 220lbs/99kg	Up to 220lbs/99kg
REAR FOOT BRAKE	✓	✓
KICKSTACK INCLUDED		✓
WHEEL SIZE AND TYPE	100mm plastic wheels	180mm plastic wheels
BEARING TYPE	ABEC-7 bearings	ABEC-7 bearings
HANDLEBAR GRIP TYPE	T-bar Soft Foam	T-bar Bike Style
HANDLEBAR HEIGHT RANGE	Quick-release adjustable height: 24"-33"	Quick-release adjustable height: 29"-39"
AVAILABLE COLOURS	Black	Grey/Red

TRACE 100

Mongoose Trace 100 scooter features Full-coverage MaxGrip on the lightweight alloy deck and steel brake to ensure a secure, stable ride, while soft foam grips offer comfortable handling. And when it's time to pack up for the day, the Trace folds for convenient storage and transport. This scooter can accommodate a wide variety of riders thanks to the quick-release adjustable height. Get performance, convenience and fun with the Trace 100.

BLACK / MMR6103AZ



100mm wheels with ABEC 7 bearings and a heavy duty frame supports up to 99kg.



Easy folding kick scooter for compact storage and transport.



Full coverage Max Grip on the deck and brake for non slip contact.



Soft foam grips for comfortable handling.



Quick release adjustable height with three lock in points to fit a wide range of riders.

TRACE 180

Mongoose Trace 180 scooter features Full-coverage MaxGrip on the lightweight alloy deck and steel brake to ensure a secure, stable ride, while wide handlebars with bike-style grips offer superior handling. The 180mm wheels come with ABEC – 7 bearings for long lasting use. Plus, the included kickstand provides convenient upright parking to protect the grips and frame from damage. And when it's time to pack up for the day, the Trace folds for convenient storage and transport.

GREY/RED / MMR4110A2



Kickstand to park your scooter upright to protect grips and frame from damage.



Easy folding kick scooter for compact storage and transport.



Full coverage Max Grip on the deck and brake for non slip contact.



180mm wheels with ABEC 8 bearings and a heavy duty frame supports up to 99kg.



Quick release adjustable height with three lock in points to fit a wide range of riders.



N
O
N
E

mongoose®